

Table of Contents

Table of Contents	1
Usage Notice	3
Introduction	6
<i>Packing Checklist</i>	6
<i>Views of Projector</i>	7
<i>Remote Control</i>	11
<i>Remote Control Operating Range</i>	13
<i>Projector and Remote Control Buttons</i>	13
<i>Inserting the Remote Control Batteries</i>	14
Setup and Operation	15
<i>Connecting Input Devices</i>	15
<i>Starting and Shutting down the Projector</i>	16
<i>Setting an Access Password (Security Lock)</i>	17
<i>Adjusting the Projector Level</i>	20
<i>Adjusting the Zoom, Focus and Keystone</i>	21
<i>Adjusting the Volume</i>	21
<i>OSD Menu Controls</i>	22
<i>Setting the OSD Language</i>	23
Menu Setting	25
<i>OSD Menu Overview</i>	25
<i>OSD Sub-Menu Overview</i>	26
<i>Display Menu</i>	31
<i>Setup Menu</i>	34
<i>Options Menu</i>	38
Appendices	41
<i>Replacing the Projection Lamp</i>	41
<i>Resetting the Lamp</i>	44
<i>Cleaning the Projector</i>	45
<i>Using the Kensington® Lock</i>	45
<i>Common problems and solutions</i>	46
<i>Tips for Troubleshooting</i>	46
<i>LED Error Messages</i>	47

Table of Contents

<i>Image Problems</i>	48
<i>Lamp Problems</i>	48
<i>Remote Control Problems</i>	49
<i>Audio Problems</i>	49
<i>Having the Projector Serviced</i>	50
Specifications	52
<i>Projection Distance V.S. Projection Size</i>	52
<i>Timing Mode Table</i>	53
<i>Projector Dimensions</i>	57
Regulatory Compliance	58
<i>FCC Warning</i>	58
<i>Canada</i>	58
<i>Safety Certifications</i>	58
<i>EN 55022 Warning</i>	58
<i>RoHS Compliant</i>	58

Congratulations and thank you for choosing an Optoma DLP projector.

Important:

It is strongly recommended that you read this section carefully before using the projector. These safety and usage instructions will ensure that you enjoy many years of safe use of the projector. Keep this manual for future reference.

Precautions

Warning symbols are used on the unit and in this manual to alert you of hazardous situations.

The following styles are used in this manual to alert you to important information.

Note:

Provides additional information on the topic at hand.

Important:

Provides additional information that should not be overlooked.

Caution:

Alerts you to situations that may damage the unit.

Warning:

Alerts you to situations that may damage the unit, create a hazardous environment, or cause personal injury.

Throughout this manual, component parts and items in the OSD menus are denoted in bold font as in this example:

“Push the **Menu** button on the remote control to open the Main menu.”

Remote Control

Some remote controls have a laser for pointing out items on a screen.

DANGER: Do not point the laser in the eyes. Doing so can damage the eyes permanently.

General Safety Information

- Do not open the unit case. Aside from the projection lamp, there are no user-serviceable parts in the unit. For servicing, contact qualified service personnel.
- Follow all warnings and cautions in this manual and on the unit case.
- The projection lamp is extremely bright by design. To avoid damage to eyes, do not look into the lens when the lamp is on.
- Do not place the unit on an unstable surface, cart, or stand.
- Avoid using the system near water, in direct sunlight, or near a heating device.
- Do not place heavy objects such as books or bags on the unit.
- Remove the lens cap to avoid high temperature damage and bad odor when the projector is switched on.

Environmental Considerations

- A. Temperatures: Operating: 5 ~ 40 °C
 Non-operation: -10°C ~ 60°C
- B. Humidity: Operating: 5% to 85%
 Non-Operation: 5% to 95%

Power Safety

- Only use the supplied power cord.
- Do not place anything on the power cord. Place the power cord where it will not be in the way of foot traffic.
- Remove the batteries from the remote control when storing or not in use for a prolonged period.

Replacing the Lamp

Replacing the lamp can be hazardous if done incorrectly. Refer to “Replacing the Projection Lamp” on page 41 for clear and safe instructions for this procedure. Before replacing the lamp:

- Unplug the power cord.
- Allow the lamp to cool for about one hour.

Important Recycle Instructions:



Lamp(s) inside this product contain mercury. This product may contain other electronic waste that can be hazardous if not disposed of properly. Recycle or dispose in accordance with local, state, or federal Laws. For more information, contact the Electronic Industries Alliance at WWW.EIAE.ORG. For lamp specific disposal information check WWW.LAMPRECYCLE.ORG.



This symbol found on your product or on its packaging, indicates that this product should not be treated as household waste when you wish to dispose of it. Instead, it should be handed over to an applicable collection point for the recycling of electrical and electronic equipment. By ensuring this product is disposed of correctly, you will help prevent potential negative consequences to the environment and human health, which could otherwise be caused by inappropriate disposal of this product. The recycling of materials will help to conserve natural resources. This symbol is only valid in the European Union. If you wish to discard this product, please contact your local authorities or dealer and ask for the correct method of disposal.

Cleaning the Projector

- Unplug the power cord before cleaning. Refer to “Cleaning the Projector” on page 45.
- Allow the lamp to cool for about one hour.

Regulatory Warnings

Before installing and using the projector, read the regulatory notices in the “Regulatory Compliance” section on page 58.

Main Features

- *Lightweight unit, easy to pack away and transport*
- *Compatible with all major video standards including NTSC, PAL, and SECAM*
- *A high brightness rating allows for presentations in daylight or in lit rooms*
- *Supports resolutions up to UXGA (for XGA model)/WXGA+ (for WXGA model) at 16.7 million colors to deliver crisp, clear images*
- *Flexible setup allows for front and rear projections*
- *Line-of-vision projections remain square, with advanced keystone correction for angled projections*
- *Input source automatically detected*

About this manual

This manual is intended for end users and describes how to install and operate the DLP projector. Wherever possible, relevant information—such as an illustration and its description—has been kept on one page. This printer-friendly format is both for your convenience and to help save paper, thereby protecting the environment. It is suggested that you only print sections that are relevant to your needs.

Packing Checklist

Carefully unpack the projector and check that the following items are included:

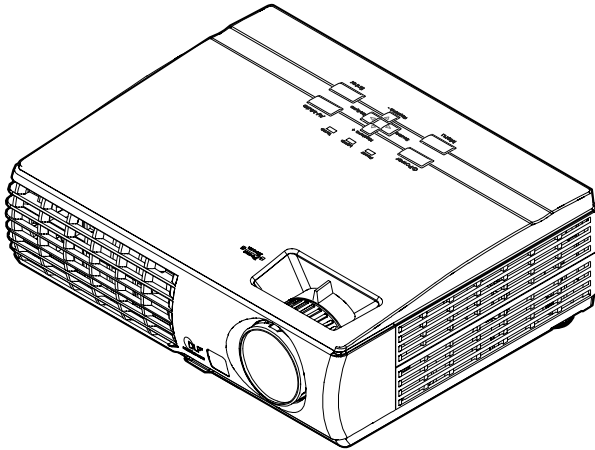

DLP PROJECTOR

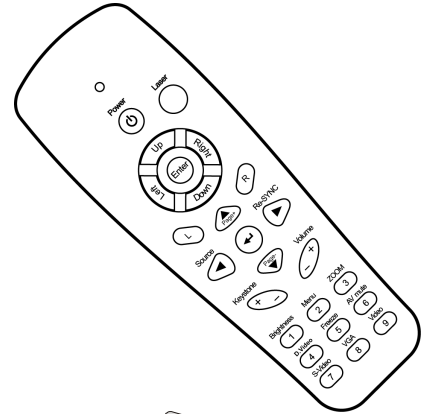

REMOTE CONTROL
(WITH TWO AAA BATTERIES)

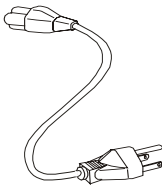

POWER CORD

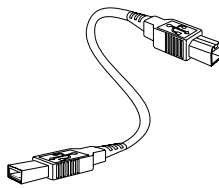

USB CABLE
(USB TYPE A TO B USB)

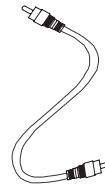

VIDEO CABLE
(RCA x 1 TO RCA x 1)

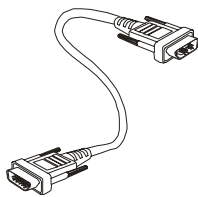

COMPUTER CABLE
(VGA TO VGA)

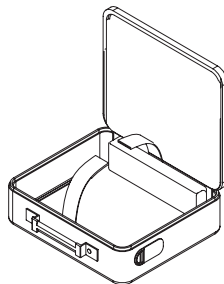

CARRYING CASE

Documents :

- User's Guide
- Quick Start Card
- Warranty Card
- WEEE Card

Contact your dealer immediately if any items are missing, appear damaged, or if the unit does not work.

Caution:
Avoid using the projector in dusty environments.

Views of Projector

Front-right View

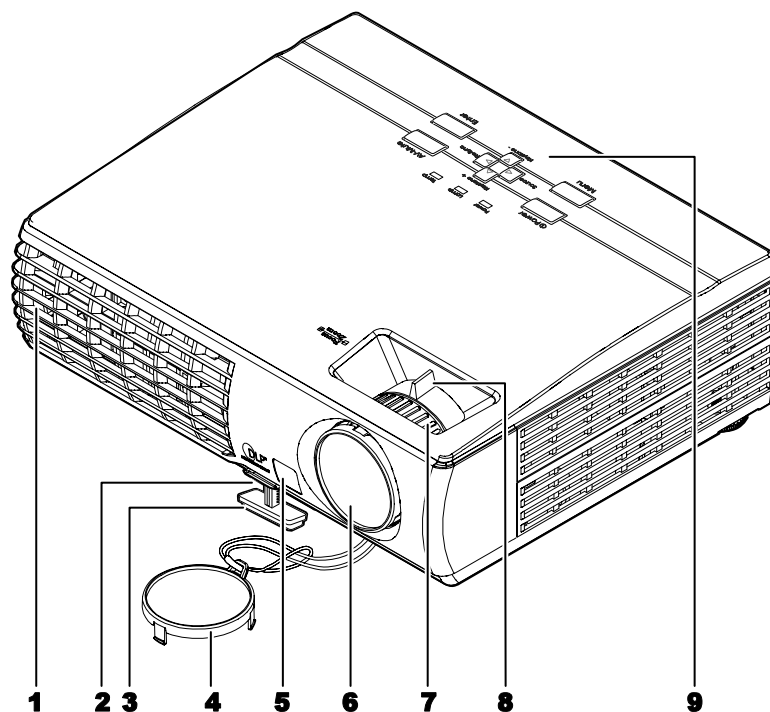

ITEM	LABEL	DESCRIPTION	SEE PAGE:
1.	Ventilation opening	To keep the projector lamp cool	
2.	Height-adjuster button	Push to release height adjustor	20
3.	Height-adjuster	Adjusts level of projector	
4.	Lens cap	Attach to protect lens when not in use	
5.	IR receiver	Receiver for IR signal from remote control	11
6.	Lens	Adjust focus/zoom on top opening	
7.	Focus	Focuses the projected image	21
8.	Zoom	Enlarges the projected image	
9.	See "Top view—OSD buttons and LEDs"		8

Important:

Ventilation openings on the projector allow for good air circulation, which keeps the projector lamp cool. Do not obstruct any of the ventilation openings.

Top view—On-screen Display (OSD) buttons and LEDs

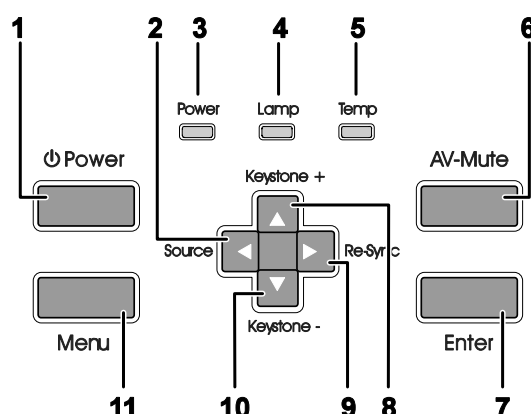

ITEM	LABEL	DESCRIPTION		SEE PAGE:
1.	Power	Turns the projector On or Off		16
2.	◀/Source (Left arrow)	Select the input device Navigates and changes settings in the OSD		
3.	Power LED	Green	Unit is powered on and working correctly	
		Flashing Green	Unit is on stand-by/cooling down	
		Off	Unit is powered off	
4.	Lamp LED	On	Lamp not ready—do not press the power button	
		Off	Lamp is in normal state	
5.	Temp LED	On	System over temperature	
		Off	Normal state	
6.	AV-Mute	Display blank and audio mute		
7.	Enter	Enter key for the OSD menu		
8.	▲/Keystone+ (Up arrow)	Corrects image-trapezoid (wider bottom) effect Navigates and changes settings in the OSD		21
9.	▶/Re-Sync (Right arrow)	Re-Sync VGA source, adjusts phase, tracking, size, position Navigates and changes settings in the OSD		
10.	▼/Keystone - (Down arrow)	Corrects image-trapezoid (wider top) effect Navigates and changes settings in the OSD		21
11.	Menu	To switch OSD menu On or Off		

Rear view

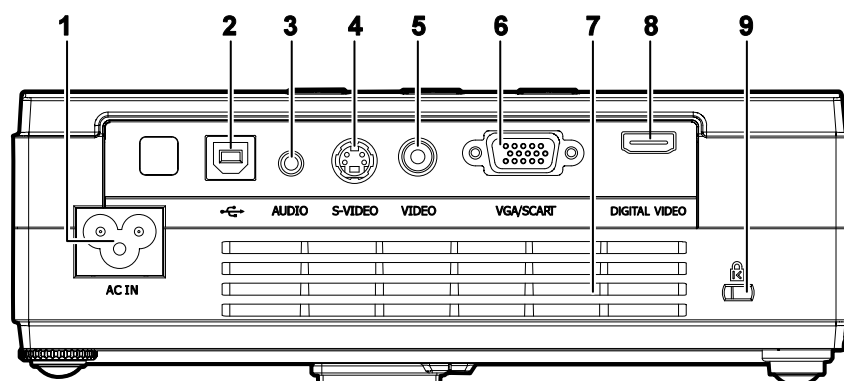

ITEM	LABEL	DESCRIPTION	SEE PAGE:
1.	AC IN (Power)	Connect the supplied power cord	16
2.	USB	Connect the USB cable from a computer	
3.	AUDIO	Connect the audio cable from an audio input device.	
4.	S-VIDEO	Connect the composite or S-video cable from a video device	
5.	VIDEO	Connect a composite video cable from a video device.	
6.	VGA/SCART	Connect a VGA cable from a computer	
7.	Ventilation opening	Do not obstruct to keep the projector cool.	
8.	DIGITAL VIDEO	Connect a DIGITAL VIDEO cable from any video source	
9.	Security Lock	Secure to permanent object with a Kensington® Lock system	45

Note:

If your video equipment has both S-video and RCA jacks (composite video) connect to the S-video connector. S-video provides a better quality signal.

Bottom view

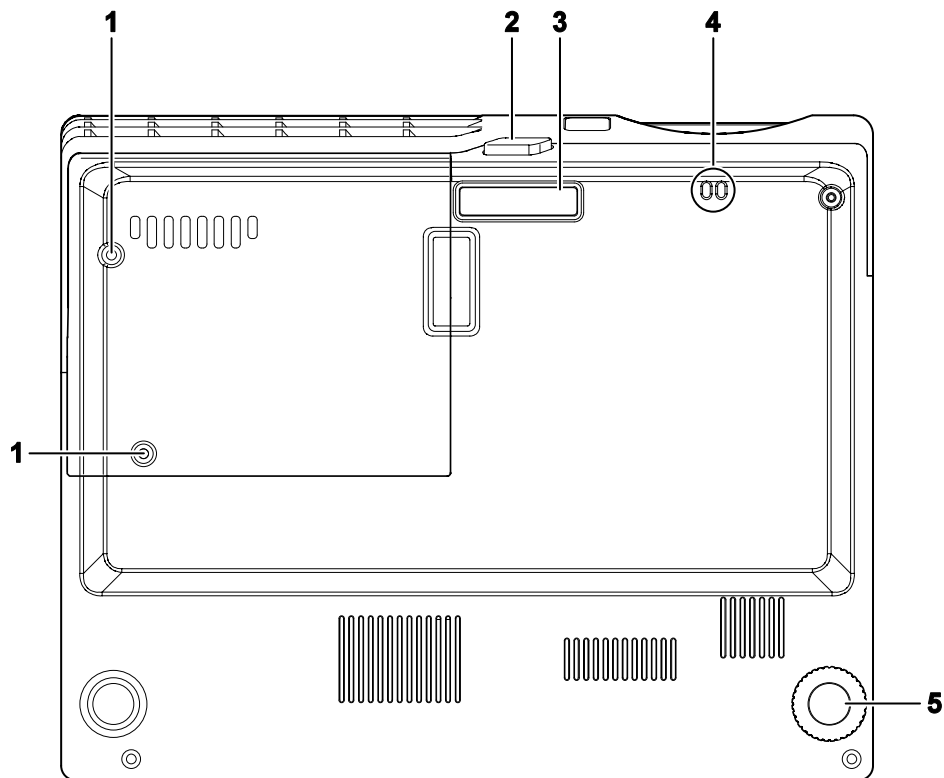

ITEM	LABEL	DESCRIPTION	SEE PAGE:
1.	Projection lamp cover screws	Remove when changing the lamp	41
2.	Height adjuster button	Push to release height adjuster	20
3.	Height adjuster	Adjuster drops down when adjuster button is pushed	
4.	Strap mount	Fasten the lens cap cover	
5.	Tilt adjuster	Rotate adjuster lever to adjust angle position	20

Remote Control

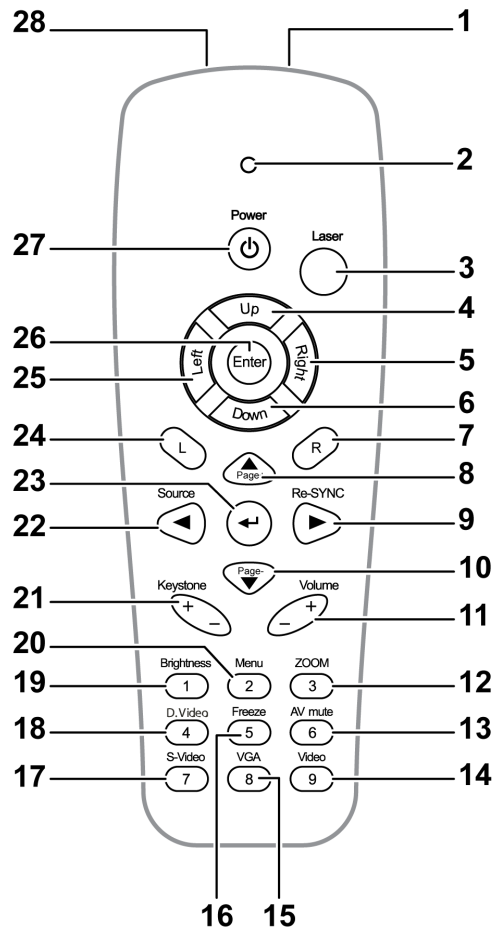

Important:

1. Avoid using the projector with bright fluorescent lighting turned on. Certain high-frequency fluorescent lights can disrupt remote control operation.

2. Be sure nothing obstructs the path between the remote control and the projector. If the path between the remote control and the projector is obstructed, you can bounce the signal off certain reflective surfaces such as projector screens.

3. The buttons and keys on the projector have the same functions as the corresponding buttons on the remote control. This user's manual describes the functions based on the remote control.

ITEM	LABEL	DESCRIPTION	SEE PAGE:
1.	IR transmitter	Transmits signals to projector	
2.	Status LED	Lights when the remote control is used	
3.	Laser	Press to operate the on-screen pointer	
4.	Up	Up arrow when connected through USB to a PC	

Introduction

5.	Right	Right arrow when connected through USB to a PC	
6.	Down	Down arrow when connected through USB to a PC	
7.	R (Right)	R key for emulation of USB mouse right click via USB	
8.	▲/Page+ (Up arrow)	Page Up key when connected through USB to a PC Navigates and changes settings in the OSD	
9.	►/Re-SYNC (Right arrow)	Navigates and changes settings in the OSD Re-Sync VGA source, adjustment for phase, tracking, size, position when OSD off	
10.	▼/Page- (Down arrow)	Page Down key when connected through USB to a PC Navigates and changes settings in the OSD	
11.	Volume +/-	Adjusts volume	21
12.	3 (ZOOM)	Zoom in and out	
13.	6 (AV mute)	Display blank & Audio mute	
14.	9 (Video)	Input source select Video	
15.	8 (VGA)	Input source select VGA	
16.	5 (Freeze)	Freeze/unfreezes the on-screen picture	
17.	7 (S-Video)	Input source select S-Video	
18.	4 (D.Video)	Input source select digital video	
19.	1 (Brightness)	Brightness menu	
20.	2 (Menu)	Opens the OSD	
21.	Keystone +/-	Corrects image-trapezoid (wider top/bottom) effect	21
22.	◀/Source	Navigates and changes settings in the OSD Input source selection when OSD Off	
23.	↵ (Enter arrow)	Changes settings in the OSD	
24.	L (Left)	L key for emulation of USB mouse left click via USB	
25.	Left	Left arrow when connected through USB to a PC	
26.	Enter	Enter key when connected through USB to a PC	
27.	Power	Turns the projector On or Off	
28.	Laser	Use as on-screen pointer. DO NOT POINT IN EYES.	

Note:

The remote control can only interface with a computer when connected to the computer through a USB cable connection. The computer cable connects a computer to the projector for display purposes only.

Remote Control Operating Range

The remote control uses infrared transmission to control the projector. It is not necessary to point the remote directly at the projector. Provided you are not holding the remote perpendicular to the sides or the rear of the projector, the remote will function well within a radius of about 10 meters (33 feet) and 30 degrees above or below the projector level.

Projector and Remote Control Buttons

The projector can be operated using the remote control or the buttons on the top of the projector. All operations can be carried out with the remote control; however the buttons on the projector are limited in use. The following illustration shows the corresponding buttons on the remote control and on the projector.

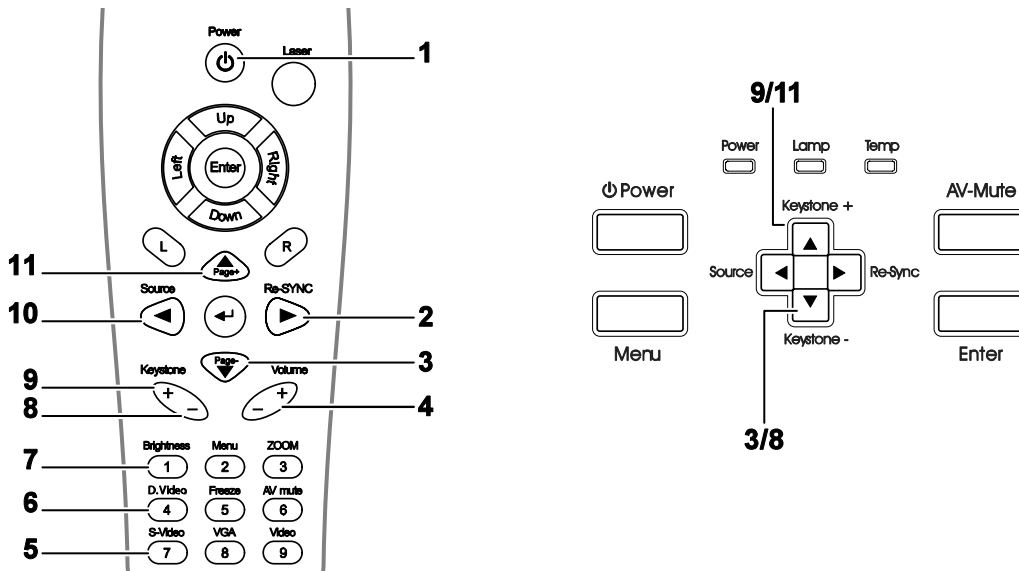

Some buttons on the projector have two functions. For example, item 9/11 on the projector functions both as the keystone button and as the up arrow key in OSD menus.

Inserting the Remote Control Batteries

1. Remove the battery compartment cover by sliding the cover in the direction of the arrow.

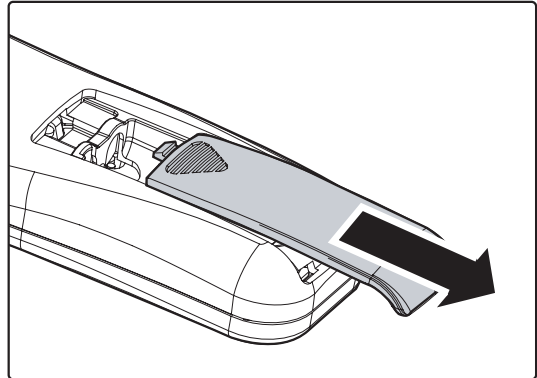

2. Insert the supplied batteries taking note of the polarity (+/-) as shown here.

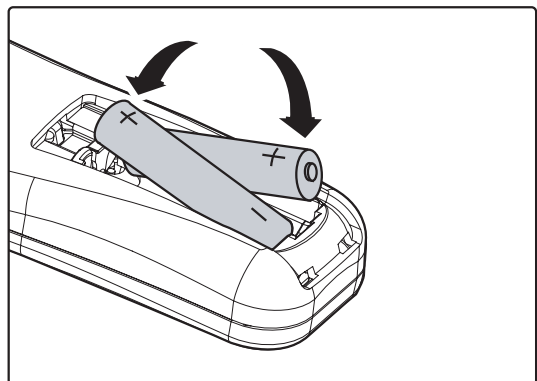

3. Replace the cover.

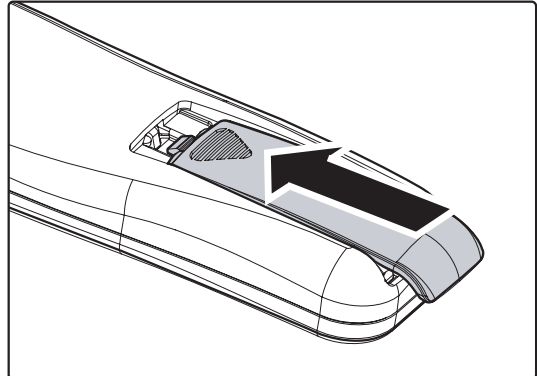

Caution:

1. Only use AAA batteries (Alkaline battery is preferred).
2. Dispose of used batteries according to local ordinance regulations.
3. Remove the batteries when not using the projector for prolonged periods.

Connecting Input Devices

A PC or notebook computer as well as video devices can be connected to the projector at the same time. Video devices include DVD, VCD, and VHS players, as well as movie camcorders and digital still cameras. Check the user manual of the connecting device to confirm it has the appropriate output connector.

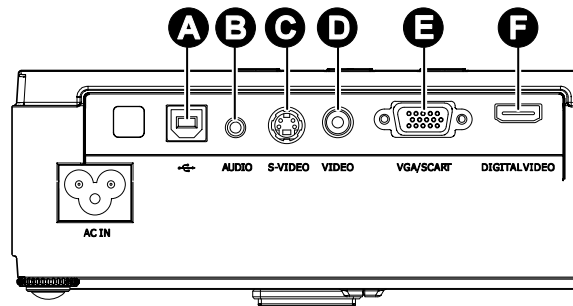

ITEM	LABEL	DESCRIPTION
A	USB	Connect the USB cable from a computer for USB mouse function and firmware upgrades.
B	AUDIO	Connect an audio cable from the computer's audio-out connector.
C	S-VIDEO	Connect the S-video cable from a video device.
D	VIDEO	Connect a composite video cable from a video device.
E	VGA/SCART	Connect a VGA cable from a computer.
F	DIGITAL VIDEO	Connect a DIGITAL VIDEO cable from any video source

Warning:

As a safety precaution, disconnect all power to the projector and connecting devices before making connections.

Starting and Shutting down the Projector

1. Connect the power cord to the projector.

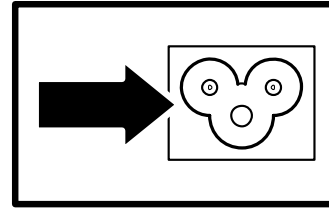

2. Turn On the connected devices.

3. Ensure the Power LED is steady (flashing) and then press the Power button to turn On the projector.

The projector splash screen displays and connected devices are detected. If the connected device is a PC, press the appropriate keys on the computer keyboard to switch the display output to the projector. (Check the user manual of the PC to determine the appropriate Fn key combination to change display output.)

See Setting an Access Password (Security Lock) on page 17 if security lock is enabled.



4. If more than one input device is connected, press the **Source** button repeatedly to switch among devices. (DVD and HDTV are supported through the VGA connector)
5. To turn off the projector, press the power button. The **Power Off? / Press Power again** message appears. Press the **Power** button again to turn off the projector.

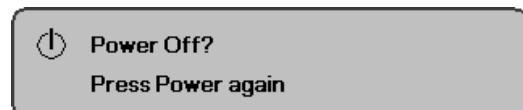

Caution:

Do not unplug the power cord until the fan stops, indicating the projector has cooled down.

Setup and Operation

Setting an Access Password (Security Lock)

You can use the arrow buttons to set a password and prevent unauthorized use of the projector. When enabled, the password must be entered after you power on the projector. (See Navigating the OSD on page 22 and Setting the OSD Language on page 23 for help on using OSD menus.)

Important:

Keep the password in a safe place. Without the password, you will not be able to use the projector. If you lose the password, contact your reseller for information on clearing the password.

1. Press the **Menu** button to open the OSD menu.

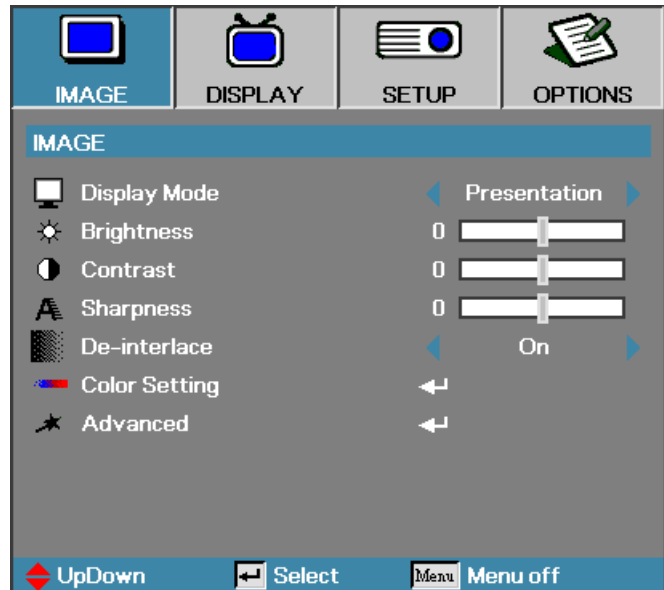

2. Press **◀▶** to move to the **SETUP** menu.

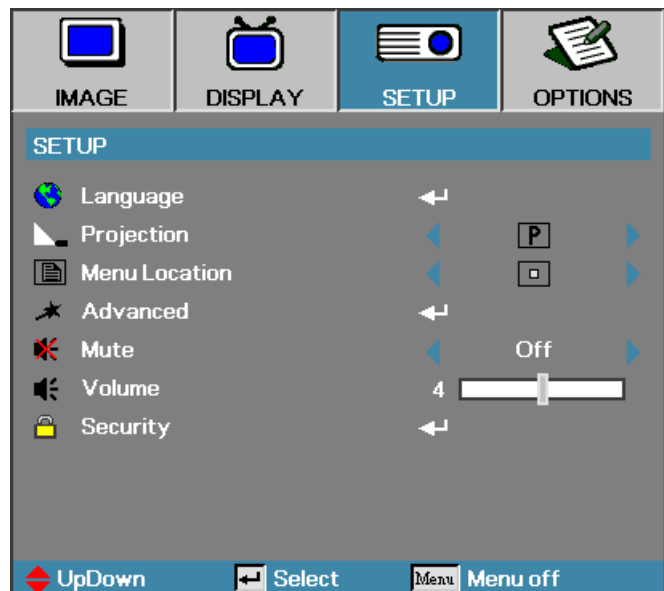

Setup and Operation

3. Press ▲ ▼ to select **Security**.

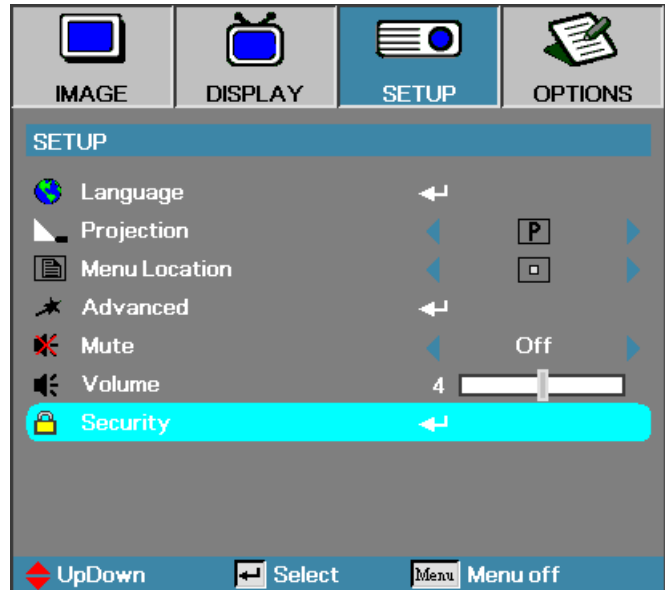

4. Press ▲ ▼ to select **Security Setting** and then press ◀ ▶ to select **Enable/Disable**.

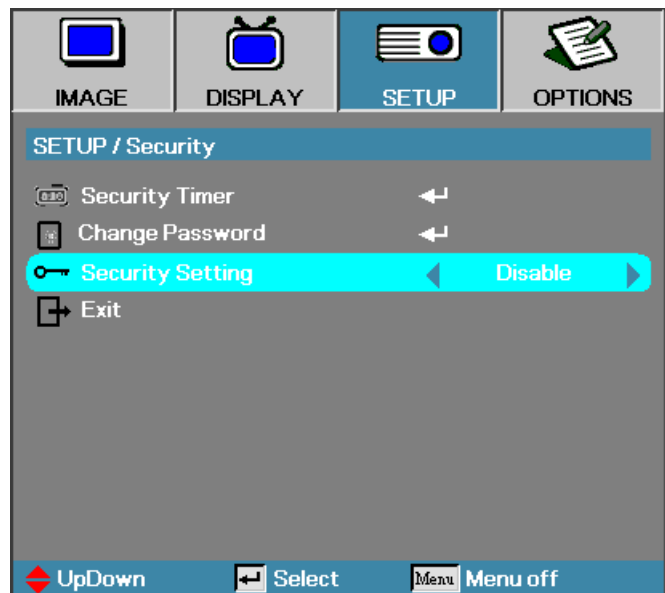

5. When the security setting is **Enabled**, you are prompted to enter a password soon after the projector is powered on.

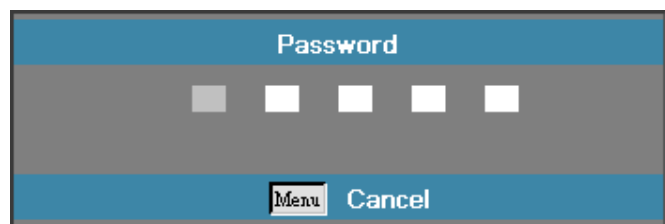

Note: If the incorrect password is entered three times the projector auto shutdowns down after 10 seconds.

The default password is: <1> <2> <3>
<4> <5>.

Setup and Operation

6. To change a password, enter the previous password when prompted.
7. Use the following keys <1>, <2>, <3>, <4>, <5>, <6>, <7>, <8>, <9> to define a new password.

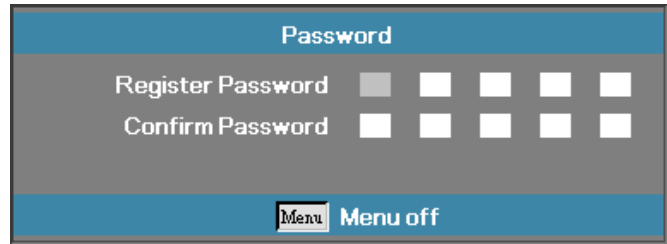

The screenshot shows a menu titled "Password" with a blue header. Below the header, there are two rows of input fields. The first row is labeled "Register Password" and contains five white square boxes, with the first box filled with a grey color. The second row is labeled "Confirm Password" and contains five white square boxes. At the bottom of the menu, there is a blue bar with a "Menu" button and the text "Menu off".

Adjusting the Projector Level

Take note of the following when setting up the projector:

- *The projector table or stand should be level and sturdy.*
- *Position the projector so that it is perpendicular to the screen.*
- *Ensure the cables are in a safe location. You could trip over them.*

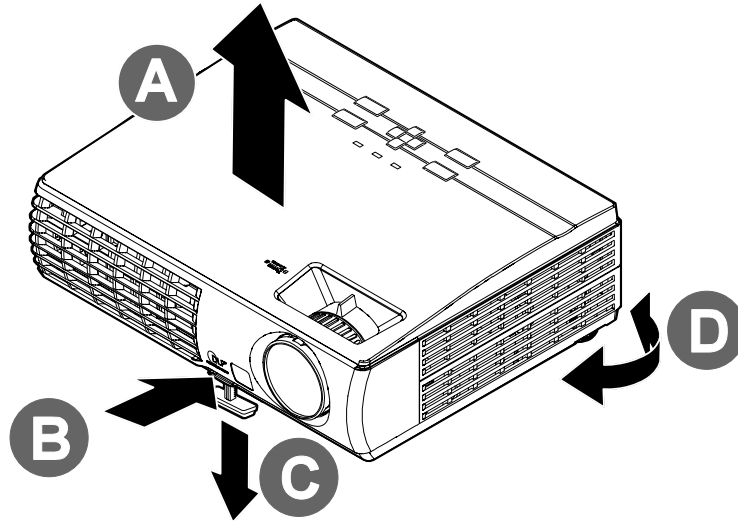

1. To raise the level of the projector, lift the projector **[A]** and press the height-adjuster button **[B]**.
The height adjuster drops down **[C]**.
2. To lower the level of the projector, press the height-adjuster button and push down on the top of the projector.
3. To adjust the angle of the picture, turn the tilt adjuster **[D]** right or left until desired angle achieved.

Adjusting the Zoom, Focus and Keystone

- Use the **Image-zoom** control (on the projector only) to resize the projected image and screen size **B**.
- Use the **Image-focus** control (on the projector only) to sharpen the projected image **A**.

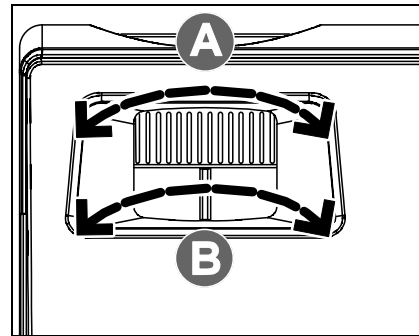

- Press the **Keystone** button on the remote control. The corresponding buttons are seen on the panel

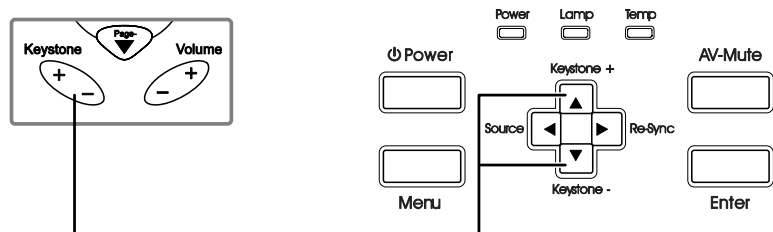

- Use the **Keystone** button to correct image distortion.



Adjusting the Volume

- Press the **Volume +/-** button on the remote control
- Use the **Volume +/-** button to adjust the level.

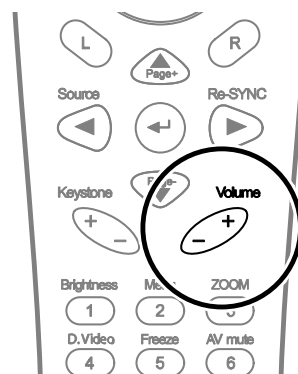

- Press the **AV mute** button on the remote control to turn off the volume.

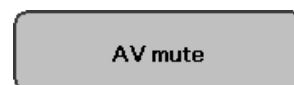

Setup and Operation

OSD Menu Controls

The projector has an OSD that lets you make image adjustments and change the settings.

Navigating the OSD

You can use the remote control arrow buttons or the buttons on the top of the projector to navigate and make changes to the OSD. The following illustration shows the corresponding buttons on the remote control and on the projector.

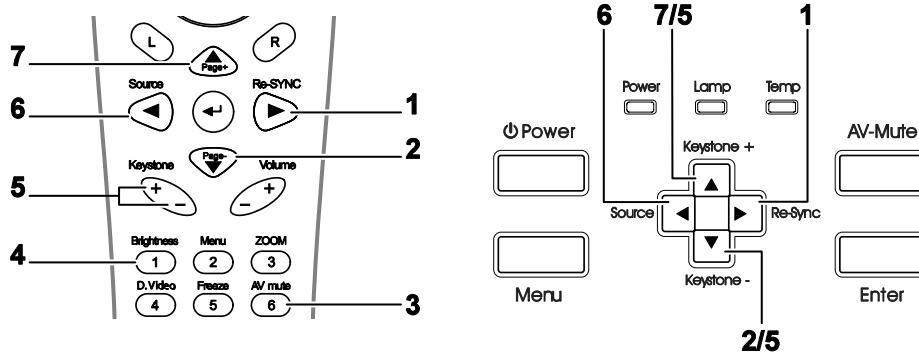

1. To open the OSD, press the **Menu** button.
2. There are four main menus. Press ◀▶ to navigate through the menus.
3. Press ▲▼ to move up and down in a menu.
4. Press ◀▶ to change values for settings, and then press **Enter** to confirm the new setting.
5. Press **Menu** to close the OSD or exit a submenu.

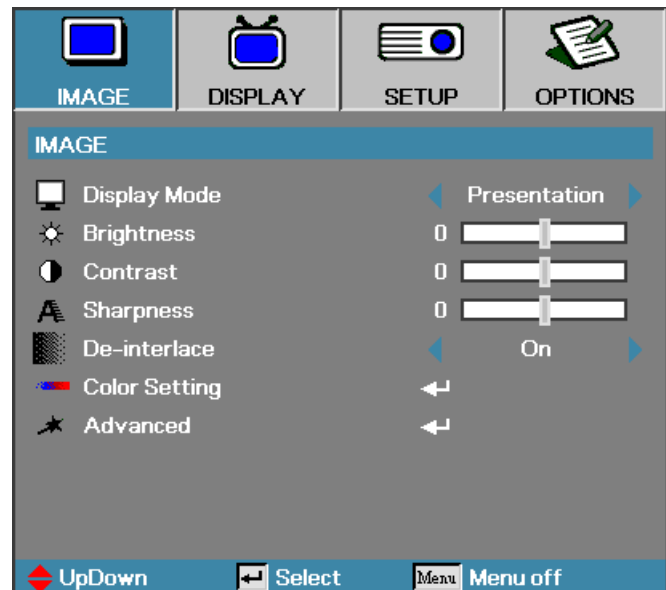

Note:

Depending on the video source not all items in the OSD are available. For example, the **Horizontal/Vertical Position** items in the Setup menu can only be modified when connected to a PC. Items that are not available cannot be accessed.

Setting the OSD Language

You may want to reference the OSD on your projector while reading this section. Set the OSD language to your preference before continuing. (The default language is English.)

1. Press the **Menu** button. Press ◀▶ to navigate to the **SETUP** menu as seen in the following screen.

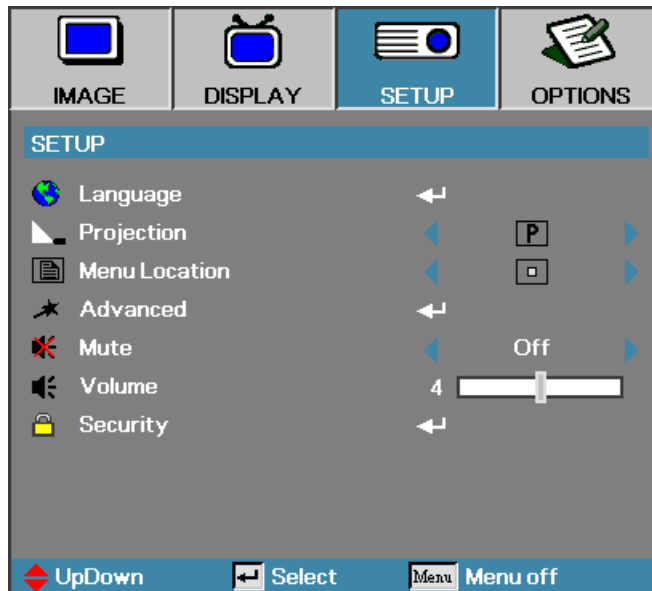

2. Press ▲▼ until **Language** is highlighted. Press **Enter** to setup your language.



Setup and Operation

3. Select the language from the **Language** menu. Press ◀▶ until your language is displayed.



4. Press **Enter** to select your language and then click **Exit**.
5. Press **Menu** to close the OSD.

OSD Menu Overview

Use the following illustration to quickly find a setting or determine the range for a setting.

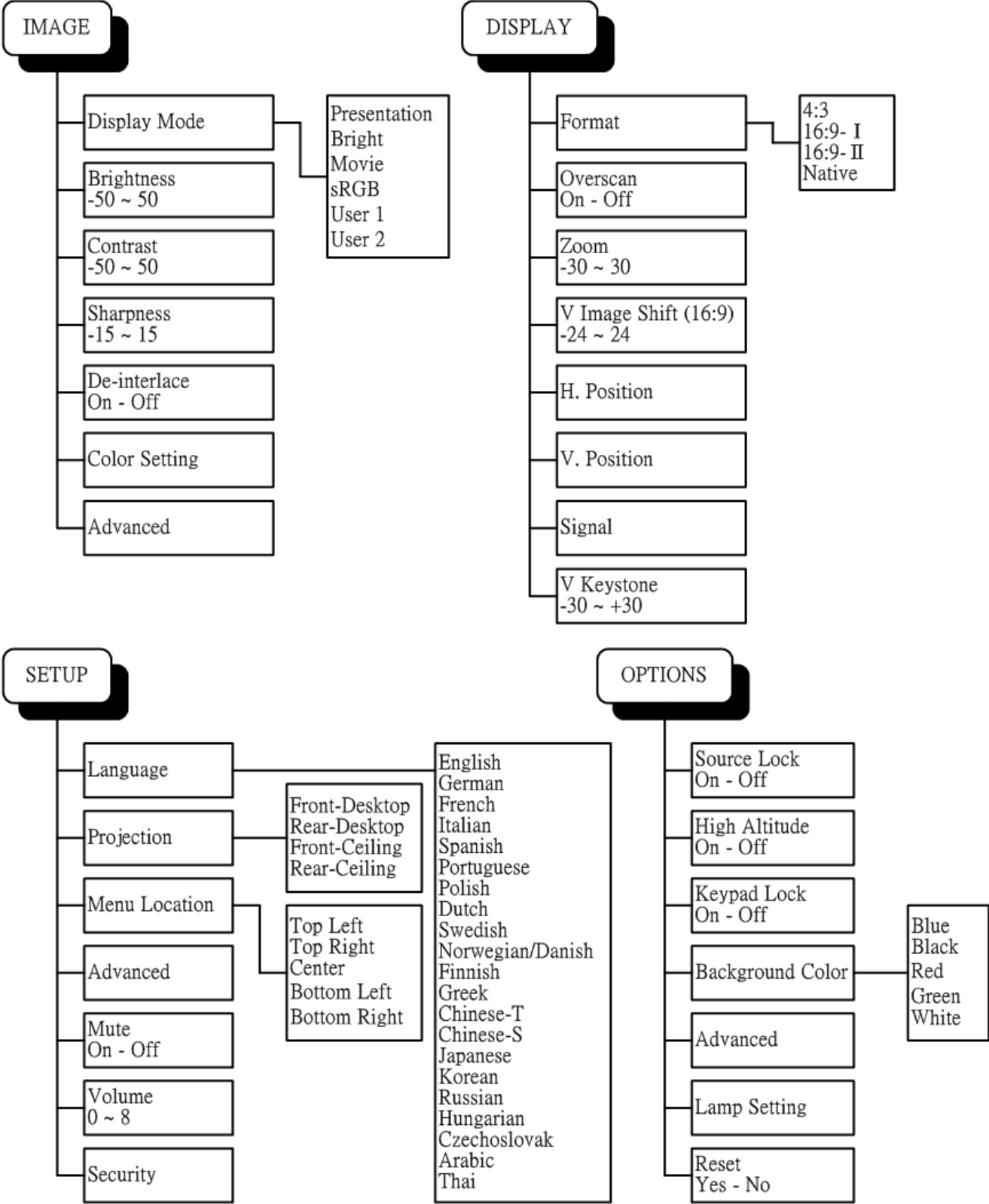

OSD Sub-Menu Overview

Use the following illustration to quickly find a setting or determine the range for a setting.

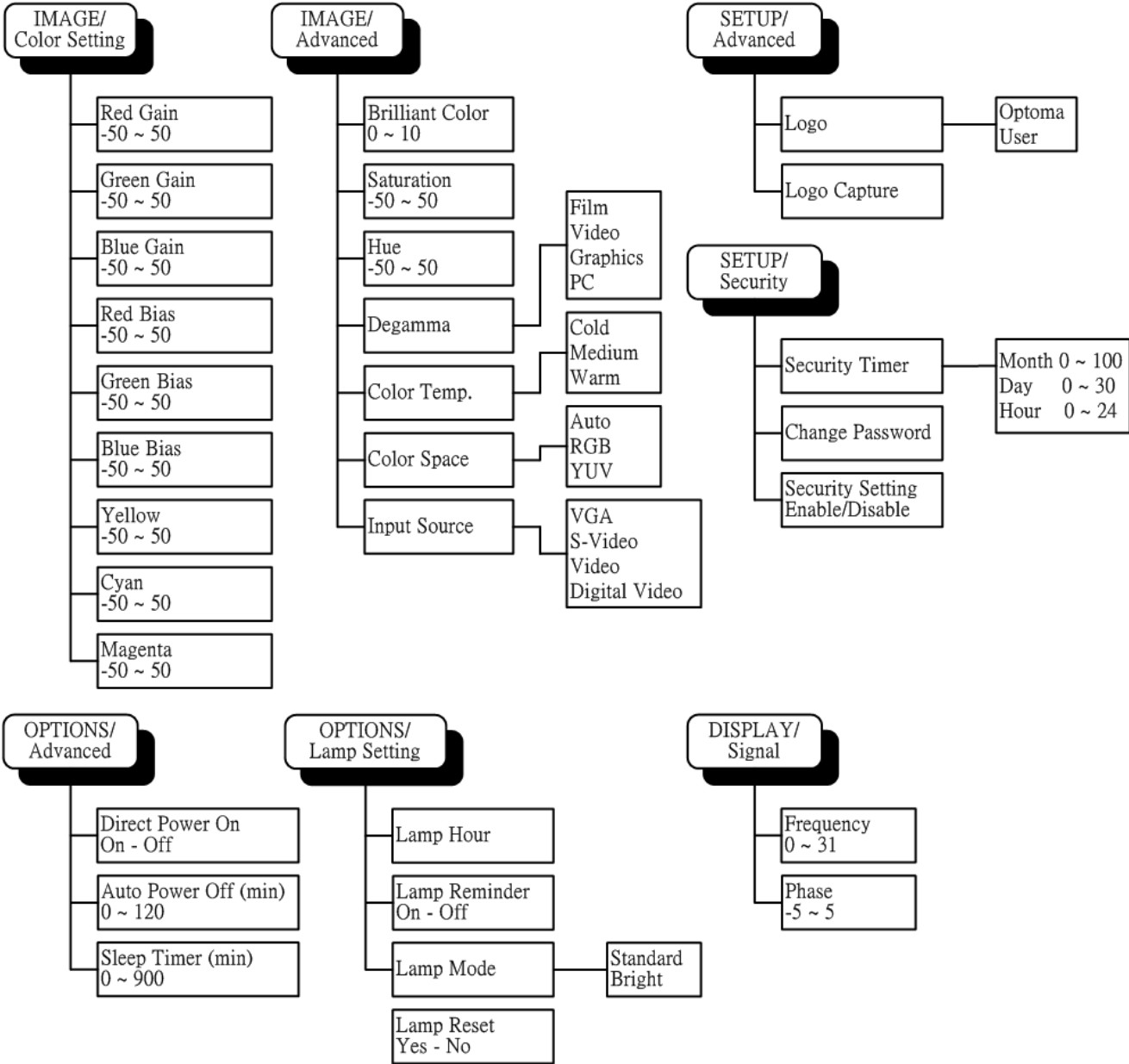
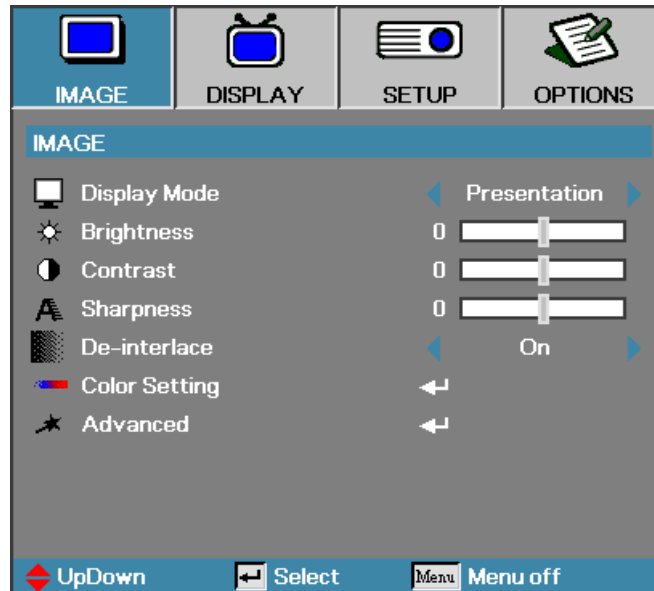

Image Menu

Press the **Menu** button to open the OSD menu. Press ◀▶ to move to the **IMAGE** menu. Press ▲▼ to move up and down in the **IMAGE** menu. Press ◀▶ to change values for settings, and then press **Enter** to confirm the new setting.



ITEM	DESCRIPTION	DEFAULT
Display Mode	There are many factory presets optimized for various types of image. Presentation: Good color and brightness from PC input. Bright: Maximum brightness from PC input. Movie: For home theatre. sRGB: Standardized accurate color. User 1: User's own settings, version 1. User 2: User's own settings, version 2.	Based on different input sources
Brightness	Adjust the brightness of the image. • Press ◀ to darken image. • Press ▶ to lighten image.	Based on different input sources or user selected display mode
Contrast	The contrast controls the degree of difference between the lightest and darkest parts of the picture. Adjusting the contrast changes the amount of black and white in the image. • Press ◀ to decrease the contrast. • Press ▶ to increase the contrast.	Based on different input sources or user selected display mode
Sharpness	Adjust the sharpness of the image. • Press ◀ to decrease the sharpness. • Press ▶ to increase the sharpness.	Based on different input sources or user selected display mode
De-interlace	Press ◀▶ to enable or disable De-interlace mode. This function converts an interlaced video signal into progressive signal.	On
Color Setting	Press Enter to open the Color Setting menu.	
Advanced	Press Enter to open the Advanced menu.	

Menu Setting

Color Setting

Press the **Menu** button to open the OSD menu. Press ◀▶ to move to the **IMAGE** menu. Press ▲▼ to move up and down in the **Color Setting** sub menu. Press ◀▶ to change values for settings, and then press **Enter** to confirm the new setting.

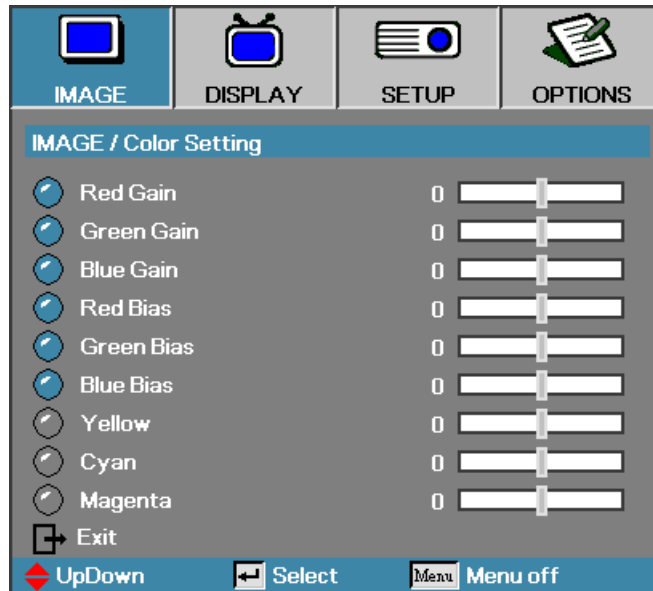

ITEM	DESCRIPTION	DEFAULT
Red Gain	Press ◀▶ to adjust the gain by altering the Color Space Converter (CSC) coefficients. The gain (brightness) can be adjusted independently for each color (R, G, B).	Based on different input sources or user selected display mode
Green Gain	Press ◀▶ to adjust the gain by altering the Color Space Converter coefficients. The gain (brightness) can be adjusted independently for each color (R, G, B).	
Blue Gain	Press ◀▶ to adjust the gain by altering the Color Space Converter coefficients. The gain (brightness) can be adjusted independently for each color (R, G, B).	
Red Bias	Press ◀▶ to adjust the contrast (Bias). The gain can be adjusted independently for each color (R, G, B).	
Green Bias	Press ◀▶ to adjust the contrast (Bias). The gain can be adjusted independently for each color (R, G, B).	
Blue Bias	Press ◀▶ to adjust the contrast (Bias). The gain can be adjusted independently for each color (R, G, B).	
Yellow	Press ◀▶ to adjust the gain of HSG (Hue Saturation Gain). The gain can be adjusted independently for each color (Y, C, M).	
Cyan	Press ◀▶ to adjust the gain of HSG (Hue Saturation Gain). The gain can be adjusted independently for each color (Y, C, M).	
Magenta	Press ◀▶ to adjust the gain of HSG (Hue Saturation Gain). The gain can be adjusted independently for each color (Y, C, M).	

Menu Setting

Advanced

Press the **Menu** button to open the OSD menu. Press ◀▶ to move to the **IMAGE** menu. Press ▲▼ to move up and down in the **Advanced** sub menu. Press ◀▶ to change values for settings, and then press **Enter** to confirm the new setting.

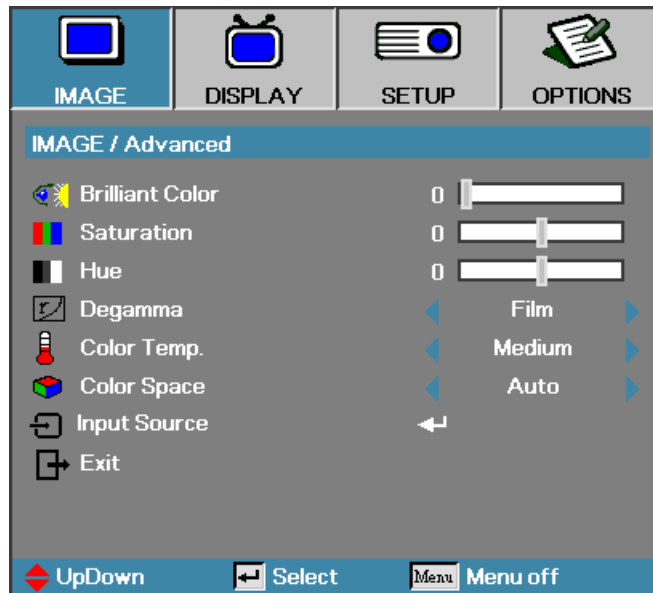

ITEM	DESCRIPTION	DEFAULT
Brilliant Color	Press ◀▶ to adjust the Brilliant Color gamut color range. This adjustable item utilizes a new color-processing algorithm and system level enhancements to enable higher brightness while providing true, more vibrant colors in picture. The range is from “0” to “10”. If you prefer a stronger enhanced image, adjust toward the maximum setting. For a smoother, more natural image, adjust toward the minimum setting.	Based on different input sources or user selected display mode
Saturation	Adjusts video image from black and white to fully saturated color. <ul style="list-style-type: none"> • Press ◀ to decrease the amount of saturation in the image. • Press ▶ to increase the amount of saturation in the image. 	
Hue	Adjusts the color balance between red and green. <ul style="list-style-type: none"> • Press ◀ to increase the amount of green in the image. • Press ▶ to increase the amount of red in the image. 	
Degamma	This allows you to choose a degamma table that has been fine-tuned to bring out the best image quality for the input. <p>Film: for home theatre. Video: for video or TV source. Graphics: for image source. PC: for PC or computer source.</p>	
Color Temp	Adjust the color temperature. Cold temperature, the screen looks colder; with Warm temperature, the screen looks warmer.	
Color Space	Select an appropriate color matrix type from AUTO, RGB, YUV.	
Input Source	Press Enter to open the Input Source menu.	

Menu Setting

Input Source

Press the **Menu** button to open the OSD menu. Press ◀▶ to move to the **IMAGE** menu. Press ▲▼ to move up and down in the **Advanced** sub menu and select **Input Source**.

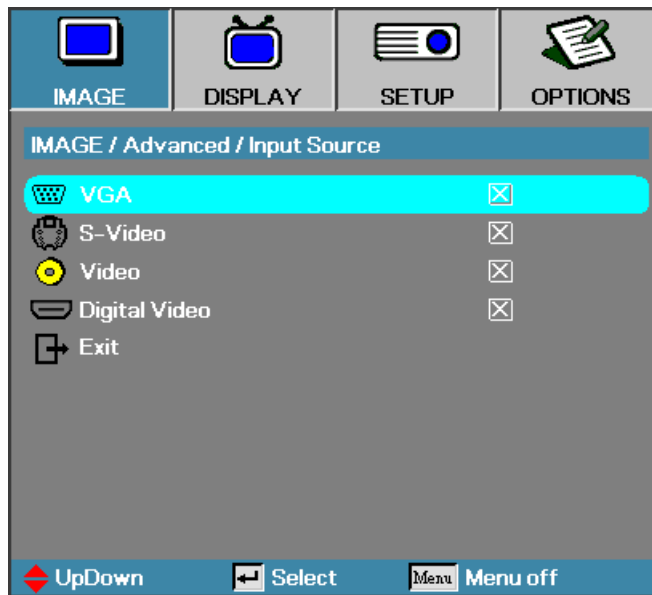

ITEM	DESCRIPTION	DEFAULT
Input Source	Press Enter to enable or disable the selection. The projector will not search for deselected inputs. If the user connects multiple sources at the same time, use the Source button on the keypad or the remote control. Available sources: VGA, S-Video, Video, Digital Video	VGA

Image Menu Functions Available for Input Sources

Function	VGA	Component Video	DIGITAL VIDEO	SCART	Composite Video	S-Video
Brilliant Color	<input type="radio"/>	<input type="radio"/>	<input type="radio"/>	<input type="radio"/>	<input type="radio"/>	<input type="radio"/>
Saturation		<input type="radio"/>		<input type="radio"/>	<input type="radio"/>	<input type="radio"/>
Hue		<input type="radio"/>		<input type="radio"/>	<input type="radio"/>	<input type="radio"/>
Degamma	<input type="radio"/>	<input type="radio"/>	<input type="radio"/>	<input type="radio"/>	<input type="radio"/>	<input type="radio"/>
Color Temp.	<input type="radio"/>	<input type="radio"/>	<input type="radio"/>	<input type="radio"/>	<input type="radio"/>	<input type="radio"/>
Color Space	<input type="radio"/>	<input type="radio"/>	<input type="radio"/>	<input type="radio"/>	<input type="radio"/>	<input type="radio"/>
Input Source	<input type="radio"/>	<input type="radio"/>	<input type="radio"/>	<input type="radio"/>	<input type="radio"/>	<input type="radio"/>

O = Available to video source

Display Menu

Press **Menu** to open the OSD menu. Press ◀▶ to move to the **DISPLAY** menu. Press ▲▼ to move up and down in the **DISPLAY** menu. Press ◀▶ to change values for settings, and then press **Enter** to confirm the new setting.

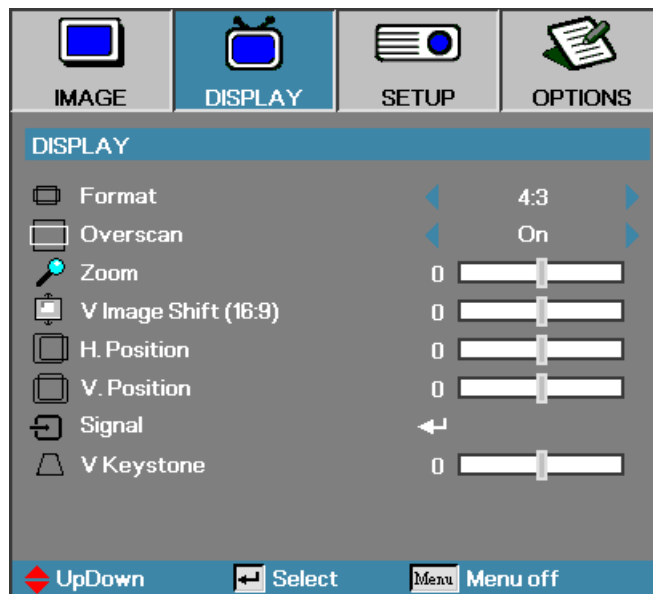

ITEM	DESCRIPTION	DEFAULT
Format	Press ◀▶ to adjust the video aspect ratio. Note: The Format function is only accessible when Zoom function is not active. Please refer to page 32 for further details.	-
Overscan	Press ◀▶ to enable or disable video overscan. Note: The Overscan function only accessible when Zoom function is not active.	Based on different input sources.
Zoom	Press ◀▶ to Zoom In and Zoom Out.	0
V Image Shift (16:9)	Press ◀▶ to adjust the image position to up or down, when selecting the format to 16:9.	Center
H.Position	Press ◀▶ to adjust the display position in horizontal direction.	Center
V.Position	Press ◀▶ to adjust the display position in vertical direction.	Center
Signal	Press Enter to open the Signal menu.	
V.Keystone	Press ◀▶ to adjust the vertical keystone.	0

Note:

For specific display settings specific to your model see the tables that follow:

WXGA

Source	480i/p	576i/p	1080i/p	720p	PC
4x3	Scale to 1024x768				
16x9-1	Scale to 1280x720				
16x 9-II	Scale to 1280x768				
Native	Depends on the resolution of the display.				

XGA

Source	480i/p	576i/p	1080i/p	720p	PC
4x3	Scale to 1024x768				
16x9-1	Scale to 1024x576				
16x 9-II	Scale to meet 1.67(1:0.6), DMD displays 1024x576 if ratio < 1.67; otherwise, it'd be the same as 16:9-1				
Native	Depends on the resolution of the display.				

Signal

Press **Menu** to open the OSD menu. Press ◀▶ to move to the **DISPLAY** menu. Press ▲▼ to move up and down and select **Signal**. Press ◀▶ to change values for settings, and then press **Enter** to confirm the new setting.

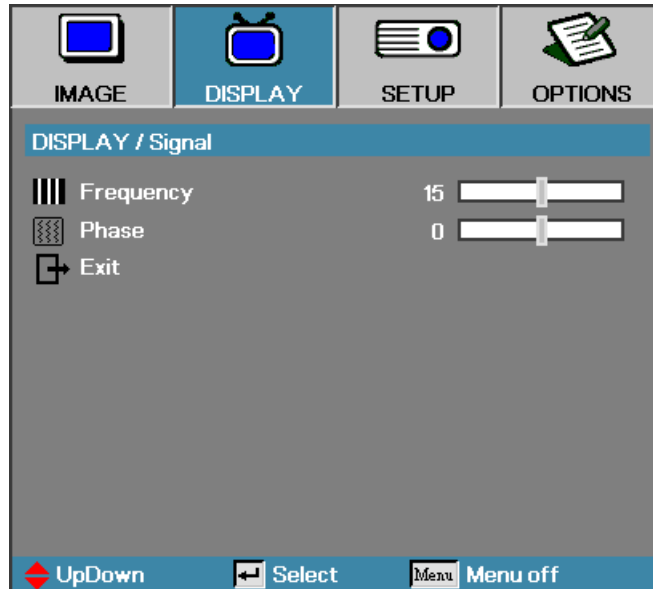

ITEM	DESCRIPTION	DEFAULT
Frequency	Press ◀▶ to adjust the A/D sampling clock.	Auto
Phase	Press ◀▶ to adjust the A/D phase.	Auto

Display Menu Functions Available for Connected Source





Function	VGA	Component Video	DIGITAL VIDEO	SCART	Composite Video	S-Video
Format	<input type="radio"/>	<input type="radio"/>	<input type="radio"/>	<input type="radio"/>	<input type="radio"/>	<input type="radio"/>
Overscan		<input type="radio"/>		<input type="radio"/>	<input type="radio"/>	<input type="radio"/>
Zoom	<input type="radio"/>	<input type="radio"/>		<input type="radio"/>	<input type="radio"/>	<input type="radio"/>
V Image Shift	<input type="radio"/>	<input type="radio"/>	<input type="radio"/>	<input type="radio"/>	<input type="radio"/>	<input type="radio"/>
H. Position	<input type="radio"/>	<input type="radio"/>				
V. Position	<input type="radio"/>	<input type="radio"/>				
Signal/Frequency	<input type="radio"/>	<input type="radio"/>				
Signal/Phase	<input type="radio"/>	<input type="radio"/>				
V Keystone	<input type="radio"/>	<input type="radio"/>	<input type="radio"/>	<input type="radio"/>	<input type="radio"/>	<input type="radio"/>

O = available to video source

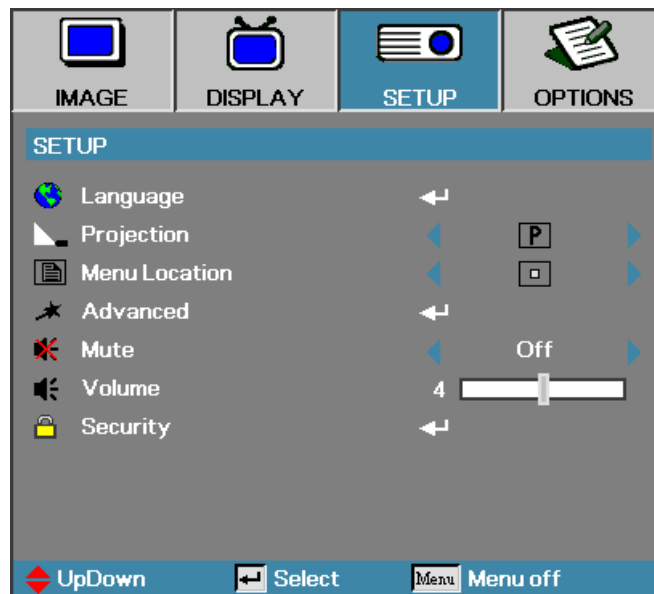
Setup Menu

Press the **Menu** button to open the OSD menu. Press ◀▶ to move to the **SETUP** menu. Press ▲▼ to move up and down in the **SETUP** menu. Press ◀▶ to change values for settings, and then press **Enter** to confirm the new setting.



ITEM	DESCRIPTION	DEFAULT
Language	Press Enter to open the language menu.	
Projection	Press ◀▶ to choose from four projection methods: <div style="display: flex; flex-direction: column; gap: 10px;"> <div> Desktop mount, front of screen</div> <div> Desktop mount, rear of screen</div> <div> Ceiling mount, front of screen</div> <div> Ceiling mount, rear of screen</div> </div>	Front-Desktop 
Menu Location	Press ◀▶ to select different OSD location.	Center
Advanced	Press Enter to open the Advanced menu.	
Mute	Press ◀▶ to turn On or Off the speaker.	Off
Volume	Press ◀▶ to adjust the audio volume level.	4
Security	Press Enter to open the Security menu.	

Note:

The Setup menu functions are available to all video sources.

Menu Setting

Language

Press the **Menu** button to open the OSD menu. Press ◀▶ to move to the **SETUP** menu. Press ▲▼ to move up and down and select **Language**. Press ◀▶ to change values for settings, and then press **Enter** to confirm the new setting.



ITEM	DESCRIPTION	DEFAULT
English	Press ◀▶ to select the desired language.	English
Italiano		
Polski		
Norsk/ Dansk		
繁體中文		
한국어		
Čeština		
Deutsch		
Español		
Nederlands		
Suomi		
简体中文		
Русский		
العربية		
Français		
Português		
Svenska		
Ελληνικά		
日本語		
Magyar		
ខ្មែរ ភាសា		

Menu Setting

Advanced

Press the **Menu** button to open the OSD menu. Press ◀▶ to move to the **SETUP** menu. Press ▲▼ to move up and down and select **Advanced**. Press ◀▶ to change values for settings, and then press **Enter** to confirm the new setting.

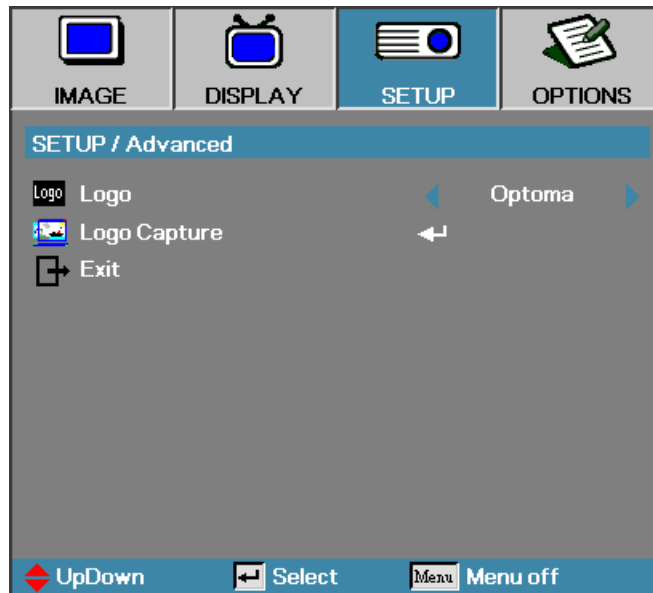

ITEM	DESCRIPTION	DEFAULT
Logo	Press ◀▶ to select the desired startup screen.	Optoma
Logo Capture	Capture the current display image as the user's logo with Logo Capture .	-

Security Timer

Press the **Menu** button to open the OSD menu. Press ◀▶ to move to the **SETUP** menu. Press ▲▼ to move up and down and select **Security**. Press ▲▼ to move up and down and select **Security Timer**. Press **Enter** to open the **Security Timer** submenu. Press ◀▶ to change values for settings, and then press **Enter** to confirm the new setting.

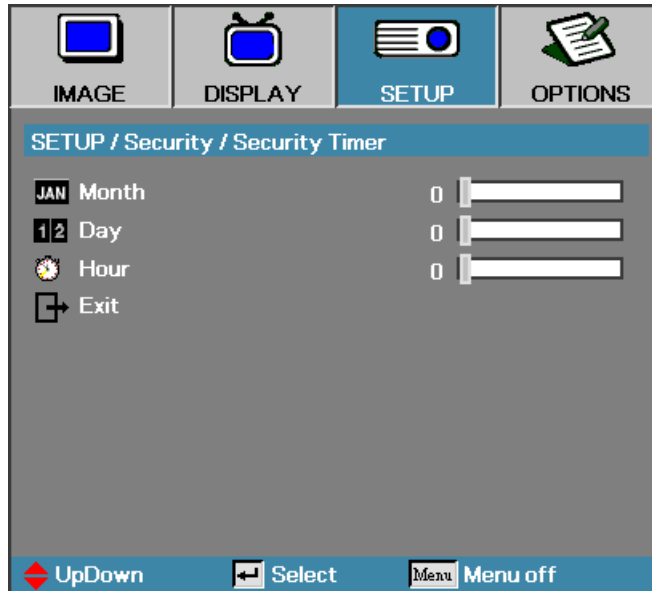

ITEM	DESCRIPTION	DEFAULT
Month	Set the number of months the projector can be used.	0
Day	Set the number of days for the projector to be active.	0
Hour	Set the number of hours for the projector to be active.	0

Options Menu

Press **Menu** to open the OSD menu. Press ◀▶ to move to the **OPTIONS** menu. Press ▲▼ to move up and down in the **OPTIONS** menu. Press ◀▶ to change values for settings, and then press **Enter** to confirm the new setting.

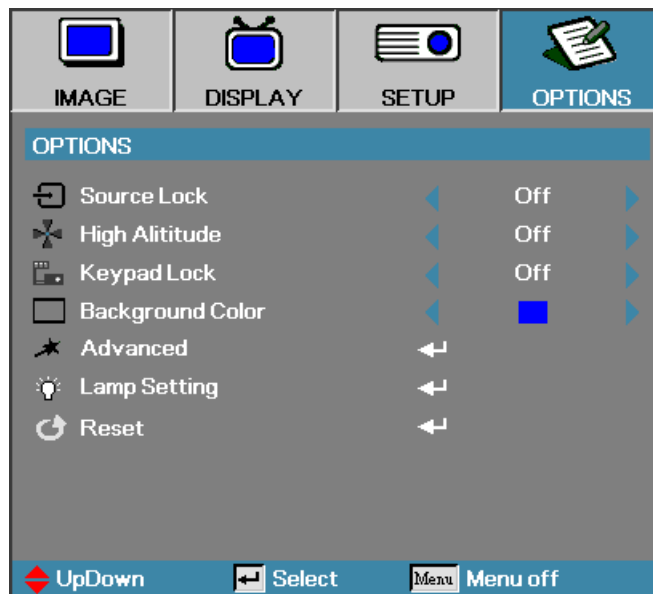

ITEM	DESCRIPTION	DEFAULT
Source Lock	Press ◀▶ to enable or disable the automatic search of all the input sources.	Off
High Altitude	Press ◀▶ to change fan speed; high speed in high temperature, high humidity or high altitude area.	Off
Keypad Lock	Press ◀▶ to enable or disable keypad function. The following warning message appears when you select On . <div style="border: 1px solid gray; padding: 5px; margin: 5px 0;">  Hold "ENTER" key on keypad for 5 seconds to unlock keypad. <div style="text-align: center; margin-top: 5px;">OK</div> </div>	Off
Background Color	Press ◀▶ to select different colors or blank screen.	Blue
Advanced	Press Enter to open the OPTIONS/Advanced menu.	
Lamp Setting	Press Enter to open the OPTIONS/Lamp Setting menu.	
Reset	Press Enter to reset all menu items to factory default. The following screen displays. Press Yes to confirm. <div style="border: 1px solid gray; padding: 10px; margin: 5px 0; text-align: center;"> <p>Confirm Reset</p> <div style="display: flex; justify-content: space-around; margin-top: 10px;"> <div style="border: 1px solid gray; padding: 5px 15px;">Yes</div> <div style="border: 1px solid gray; padding: 5px 15px;">No</div> </div> </div>	

Menu Setting

Advanced

Press **Menu** to open the OSD menu. Press ◀▶ to move to the **OPTIONS** menu. Press ▲▼ to move up and down in the **OPTIONS** menu. Select **Advanced** and press **Enter** to open the sub menu. Press ◀▶ to change values for settings, and then press **Enter** to confirm the new setting.

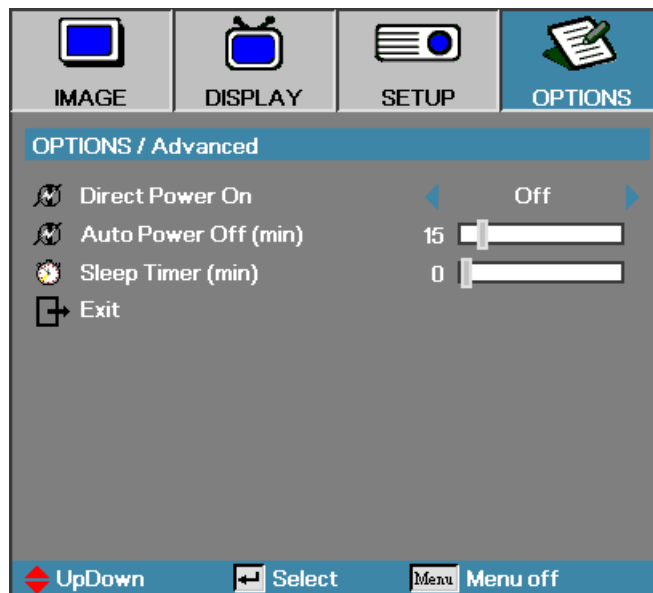

ITEM	DESCRIPTION	DEFAULT
Direct Power On	If the user selects On the projector will automatically power on when AC power is supplied.	Off
Auto Power Off (min)	Set the projector to automatically switch off the lamp when there is no signal in minutes.	15
Sleep Timer (min)	Sets the countdown timer interval. The timer will begin, with or without a signal input. Then the projector will automatically power Off when the sleep timer countdown stops (in minutes).	0

Note:

Press any keypad/IR button to restore the original timer setting when a warning message displays.

Lamp Setting

Press **Menu** to open the OSD menu. Press ◀▶ to move to the **OPTIONS** menu. Press ▲▼ to move up and down in the **OPTIONS** menu. Select **Lamp Setting** in the **OPTIONS** menu. Press ◀▶ to change values for settings, and then press **Enter** to confirm the new setting.

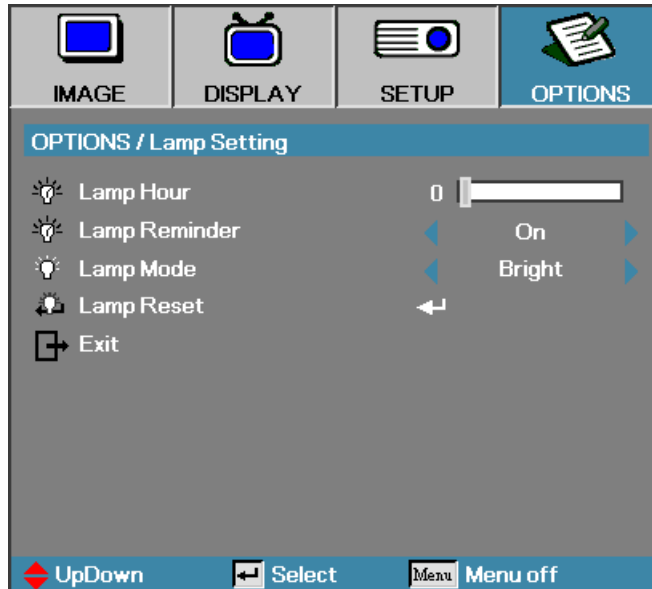

ITEM	DESCRIPTION	DEFAULT
Lamp Hour	Set the number of hours for the lamp to be active. Standard and bright counter are separated.	–
Lamp Reminder	Show or hide the warning message Note: The lamp reminder warning is only displayed when less than 30 hours remain.	On
Lamp Mode	Select the lamp mode for higher or lower brightness to save lamp life.	Bright
Lamp Reset	Press Enter to reset the lamp life hour after replacing the lamp. See Resetting the Lamp on page 44.	

Replacing the Projection Lamp

The projection lamp should be replaced when it burns out. It should only be replaced with a certified replacement part, which you can order from your local dealer.

Important:

1. The lamp contains a certain amount of mercury and should be disposed of according to local ordinance regulations.

2. Avoid touching the glass surface of the new lamp, doing so may shorten its operation life.

Warning:

Be sure to turn off and unplug the projector at least an hour before replacing the lamp. Failure to do so could result in a severe burn.

1. Loosen the two captive screws on the lamp compartment cover (A). Remove the lamp compartment cover (B).

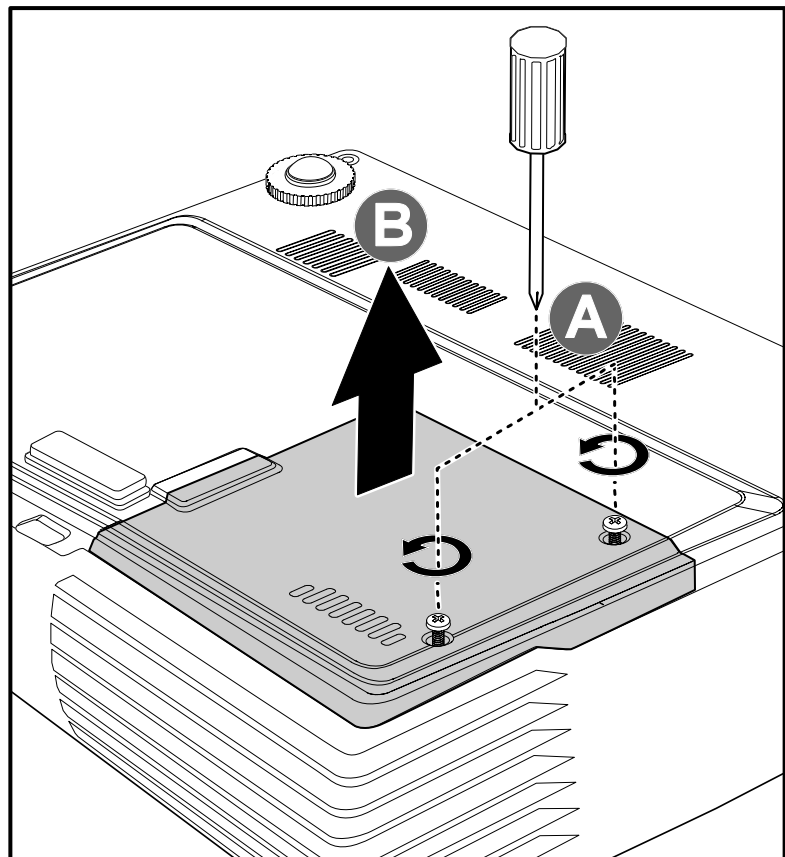

2. Remove the two screws from the lamp module (A).

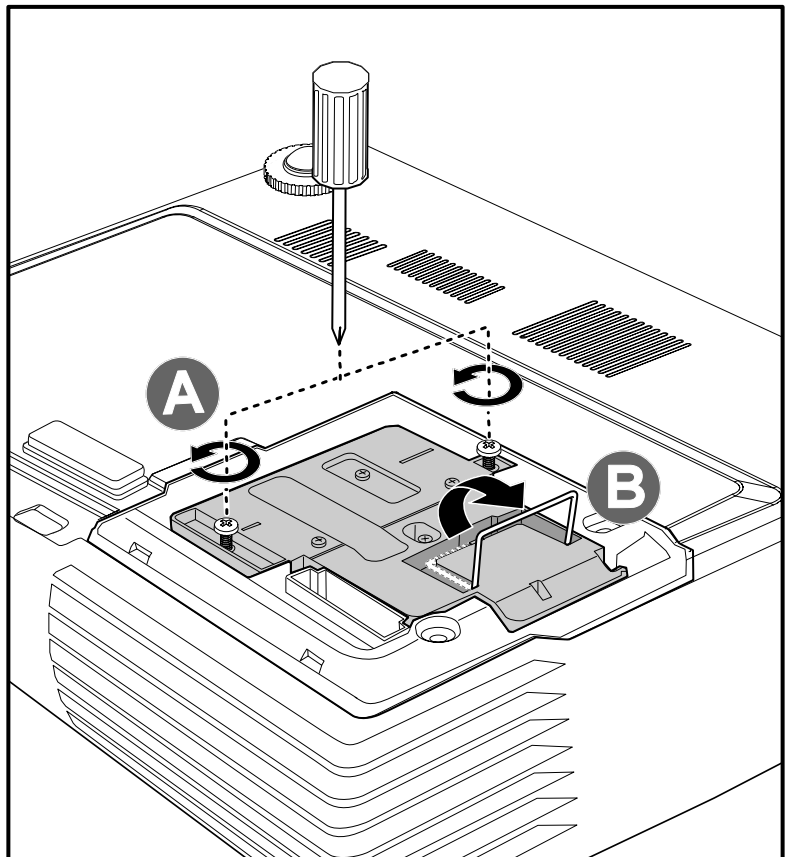

3. Lift the module handle up (B).

4. Pull firmly on the module handle to remove the lamp module.

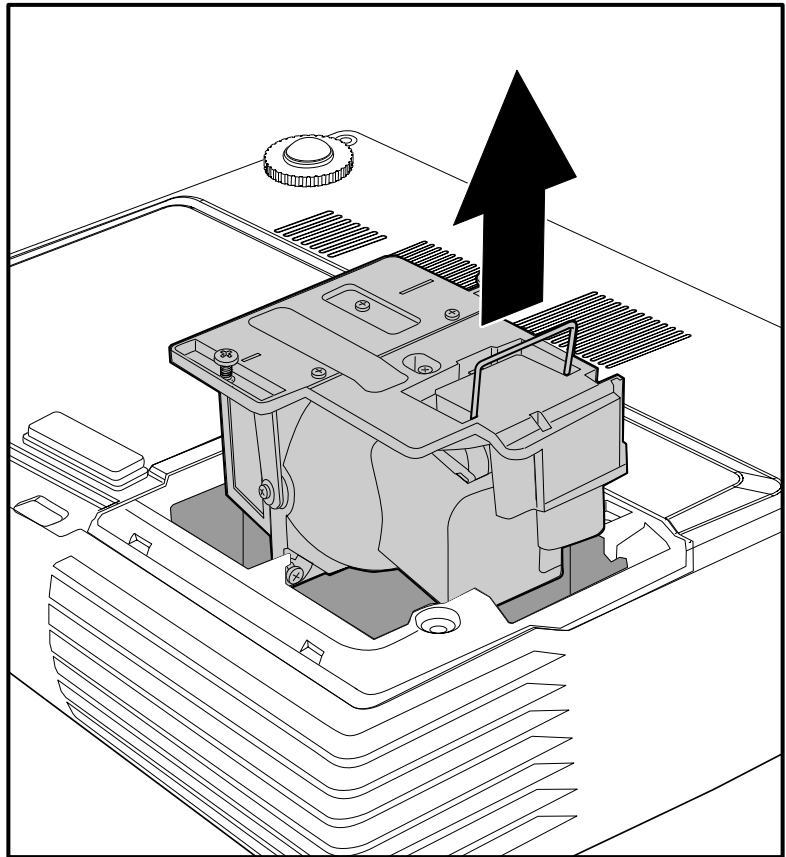

5. Reverse steps 1 to 5 to replace the new lamp module.

Resetting the Lamp

After replacing the lamp, you should reset the lamp hour counter to zero. Refer to the following:

1. Press the **Menu** button to open the **Image** menu.
2. Press ◀▶ to navigate to the **OPTIONS** menu.
3. Press ▲▼ to navigate to **Lamp Setting** and then press **Enter**.

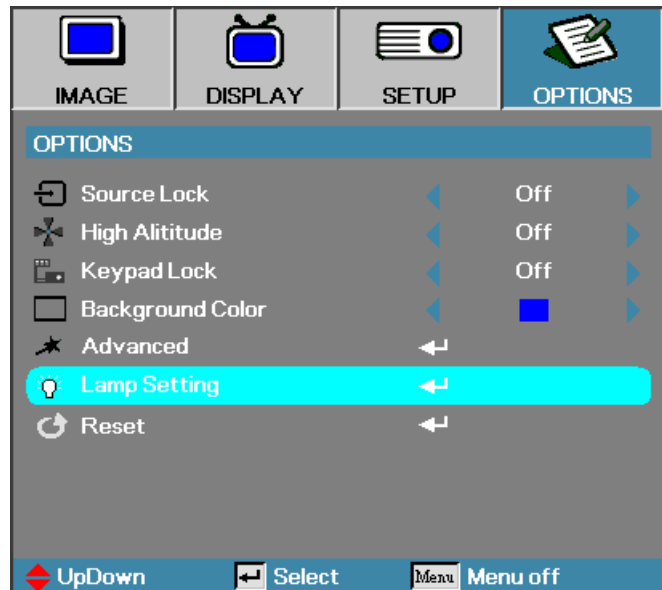

4. Navigate down to **Lamp Reset** and then press ▶ or **Enter**.

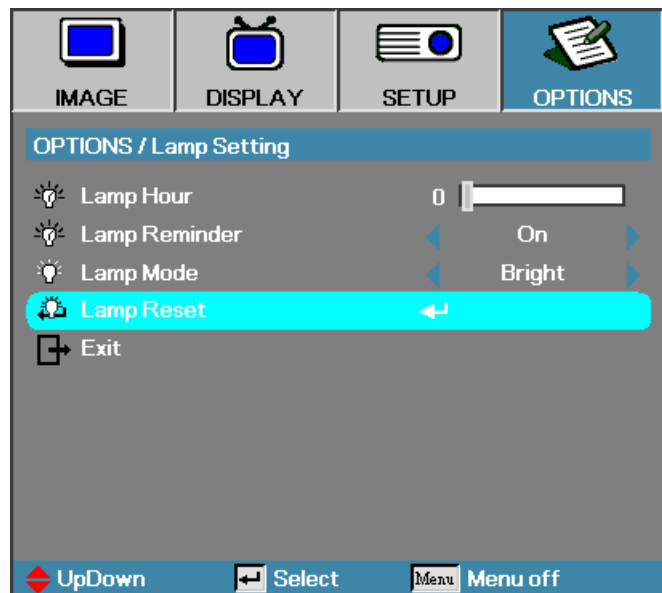

5. A **Confirm Lamp Reset** message displays. Select **Yes** to confirm the lamp reset.



Cleaning the Projector

Cleaning the projector to remove dust and grime will help ensure trouble-free operation.

Warning:

1. Be sure to turn off and unplug the projector at least an hour before cleaning. Failure to do so could result in a severe burn.
2. Use only a dampened cloth when cleaning. Do not allow water to enter the ventilation openings on the projector.
3. If a little water gets into the projector interior while cleaning, leave unplugged in a well-ventilated room for several hours before using.
4. If a lot of water gets into the projector interior when cleaning, have the projector serviced.

Cleaning the Lens

You can purchase optic lens cleaner from most camera stores. Refer to the following to clean the projector lens.

1. Apply a little optic lens cleaner to a clean soft cloth. (Do not apply the cleaner directly to the lens.)
2. Lightly wipe the lens in a circular motion.

Caution:

1. Do not use abrasive cleaners or solvents.
2. To prevent discoloration or fading, avoid getting cleaner on the projector case.

Cleaning the Case

Refer to the following to clean the projector case.

1. Wipe off dust with a clean dampened cloth.
2. Moisten the cloth with warm water and mild detergent (such as used to wash dishes), and then wipe the case.
3. Rinse all detergent from the cloth and wipe the projector again.

Caution:

To prevent discoloration or fading of the case, do not use abrasive alcohol-based cleaners.

Using the Kensington® Lock

If you are concerned about security, attach the projector to a permanent object with the Kensington slot and a security cable.

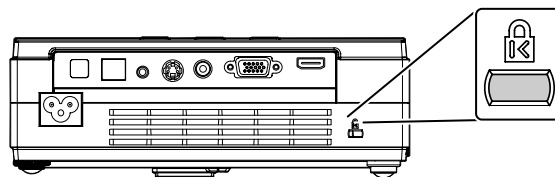

Common problems and solutions

These guidelines provide tips to deal with problems you may encounter while using the projector. If the problem remains unsolved, contact your dealer for assistance.

Often after time spent troubleshooting, the problem is traced to something as simple as a loose connection. Check the following before proceeding to the problem-specific solutions.

- *Use some other electrical device to confirm that the electrical outlet is working.*
- *Ensure the projector is turned on.*
- *Ensure all connections are securely attached.*
- *Ensure the attached device is turned on.*
- *Ensure a connected PC is not in suspended mode.*
- *Ensure a connected notebook computer is configured for an external display. (This is usually done by pressing an Fn-key combination on the notebook.)*

Tips for Troubleshooting

In each problem-specific section, try the steps in the order suggested. This may help you to solve the problem more quickly.

Try to pin point the problem and thus avoid replacing non-defective parts.

For example, if you replace batteries and the problem remains, put the original batteries back and go to the next step.

Keep a record of the steps you take when troubleshooting-the information may be useful when calling for technical support or for passing on to service personnel.

LED Error Messages

ERROR CODE MESSAGE	POWER LED/FLASHES	LAMP LED/FLASHES
Thermal break status error	4	0
Fan1 error (Power Fan)	6	1
Fan2 error (Lamp Fan)	6	2
Fan3 error (Blower Fan)	6	3
Lamp door sensor detect high	7	0
DMD error	8	0
Color wheel error	9	0

Image Problems

Problem: No image appears on the screen

1. Verify the settings on your notebook or desktop PC.
2. Turn off all equipment and power on again in the correct order.

Problem: The image is blurred

1. Adjust the **Focus** on the projector.
2. Press the **Re-Sync** button on the remote control or projector.
3. Ensure the projector-to-screen distance is within the 10-meter (33-foot) specified range.
4. Check that the projector lens is clean.

Problem: The image is wider at the top or bottom (trapezoid effect)

1. Position the projector so it is as perpendicular to the screen as possible.
2. Use the Keystone button on the remote control or projector to correct the problem.

Problem: The image is reversed or upside down

Check the **Projection** setting on the **SETUP** menu of the OSD.

Problem: The image is streaked

1. Set the **Frequency** and **Tracking** settings on the **DISPLAY** menu of the OSD to the default settings.
2. To ensure the problem is not caused by a connected PC's video card, connect to another computer.

Problem: The image is flat with no contrast

Adjust the **Contrast** setting on the Main menu of the OSD.

Problem: The color of the projected image does not match the source image.

Adjust the **Color Temperature** and **Gamma** settings on the Main menu of the OSD.

Lamp Problems

Problem: There is no light from the projector

1. Check that the power cable is securely connected.
2. Ensure the power source is good by testing with another electrical device.
3. Restart the projector in the correct order and check that the Power LED is green.
4. If you have replaced the lamp recently, try resetting the lamp connections.
5. Replace the lamp module.
6. Put the old lamp back in the projector and have the projector serviced.

Problem: The lamp goes off

1. Power surges can cause the lamp to turn off. Press the power button twice to turn off the projector. When the Ready LED is on, press the power button.
2. Replace the lamp module.
3. Put the old lamp back in the projector and have the projector serviced.

Remote Control Problems

Problem: The projector does not respond to the remote control

1. Direct the remote control towards remote sensor on the projector.
2. Ensure the path between remote and sensor is not obstructed.
3. Turn off any fluorescent lights in the room.
4. Check the battery polarity.
5. Replace the batteries.
6. Turn off other Infrared-enabled devices in the vicinity.
7. Have the remote control serviced.

Audio Problems

Problem: There is no sound

1. Adjust the volume on the remote control.
2. Adjust the volume of the audio source.
3. Check the audio cable connection.
4. Test the source audio output with other speakers.
5. Have the projector serviced.

Problem: The sound is distorted

1. Check the audio cable connection.
2. Test the source audio output with other speakers.
3. Have the projector serviced.

Having the Projector Serviced

If you are unable to solve the problem, you should have the projector serviced. Pack the projector in the original carton. Include a description of the problem and a checklist of the steps you took when trying to fix the problem--the information may be useful to service personnel.

Optoma Global Offices

For service or support, please contact your local office.

USA

715 Sycamore Drive
Milpitas, CA 95035, USA
Tel: +1-408-383-3700
Fax: +1-408-383-3702

www.optomausa.com

Service: services@optoma.com

Canada

5630 Kennedy Road,
Mississauga, ON, L4Z 2A9, Canada
Tel: 905-361-2582
Fax: 905-361-2581

www.optoma.ca

Europe

42 Caxton Way, The Watford Business Park
Watford, Hertfordshire, WD18 8QZ, UK
Tel: +44 (0) 1923 691 800
Fax: +44 (0) 1923 691 888

www.optoma.eu

Service Tel: +44 (0) 1923 691 865

Service: service@tsc-europe.com

France

Bâtiment E, 81-83 avenue Edouard Vaillant
92100 Boulogne Billancourt, France
Tel: +33 1 41 46 12 20
Fax: +33 1 41 46 94 35

Service: savoptoma@optoma.fr

Spain

Paseo de la Castellana, 135 7 Planta
Madrid, Spain
Tel.: +34 91 790 67 01
+34 91 790 67 02
Fax: + 34 91 790 68 69

Taiwan

5F, No. 108, Minchiuan Rd.
Shindian City, Taipei Taiwan 231
Tel: +886-2-2218-2360
Fax: +886-2-2218-2313

www.optoma.com.tw

Service: services@optoma.com.tw

Hong Kong

Unit A, 27/F Dragon Center, 79 Wing Hong Street,
Cheung Sha Wan, Kowloon, Hong Kong

Tel: +852-2396-8968

Fax: +852-2370-1222

www.optoma.com.hk

China

5F, No. 1205, Kaixuan Rd.,
Changning District, Shanghai, 200052, China
Tel: +86-21-62947376

Fax: +86-21-62947375

www.optoma.com.cn

Korea

WOOMI TECH.CO.LTD.
4F,Minu Bldg.33-14, Kangnam-Ku,
Seoul, 135-815, KOREA
Tel: +82+2+34430004
Fax: +82+2+34430005

Japan

東京都足立区綾瀬3-25-18
オーエス本社ビル
サポートセンター:0120-46-5040

E-mail: info@osscreen.com

www.os-worldwide.com

Scandinavia

Grev Wedels Plass 2, 3015 Drammen
Norway
Tel: +47 32 26 89 90
Fax: +47 32 83 78 98

Service: info@optoma.no

Deutschland

Werftstrasse 25, D40549 Düsseldorf
Germany
Tel: +49 (0) 211 506 6670
Fax: +49 (0) 211 506 66799

Service: info@optoma.de

Latin America

715 Sycamore Drive
Milpitas, CA 95035, USA
Tel: 408-383-3700
Fax: 408-383-3702

www.optoma.com.br
www.optoma.com.mx

Latin America

715 Sycamore Drive, Milpitas, CA 95035, USA
Tel: 408-383-3700
Fax: 408-383-3702

www.optoma.com.mx

Projection Distance V.S. Projection Size

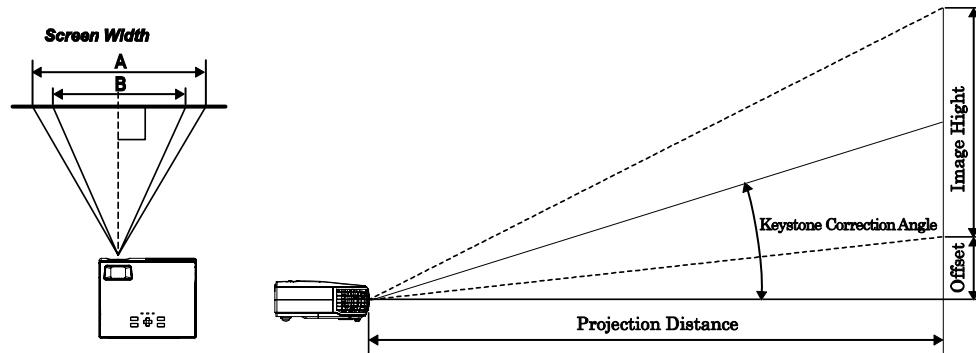

Projection Distance L	Max. Screen Size (Wide)					Max. Screen Size (Tele)					
	Diagonal		Height C	Width A		Projection Distance L	Diagonal		Height D	Width B	
	XGA	WXGA		XGA	WXGA		XGA	WXGA		XGA	WXGA
1.16m	0.76m	0.89m	0.46m	0.61m	0.76m	1.34m	0.76m	0.89m	0.46m	0.61m	0.76m
3.8'	30"	35"	18"	24"	30"	4.4'	30"	35"	18"	24"	30"
2.32m	1.52m	1.78m	0.91m	1.22m	1.52m	2.68m	1.52m	1.78m	0.91m	1.22m	1.52m
7.6'	60"	70"	36"	48"	60"	8.8'	60"	70"	36"	48"	60"
3.47m	2.29m	2.67m	1.37m	1.83m	2.29m	4.02m	2.29m	2.67m	1.37m	1.83m	2.29m
11.4'	90"	105"	54"	72"	90"	13.2'	90"	105"	54"	72"	90"
4.63m	3.05m	3.55m	1.83m	2.44m	3.05m	5.36m	3.05m	3.55m	1.83m	2.44m	3.05m
15.2'	120"	140"	72"	96"	120"	17.6'	120"	140"	72"	96"	120"
5.79m	3.81m	4.44m	2.29m	3.05m	3.81m	6.71m	3.81m	4.44m	2.29m	3.05m	3.81m
19'	150"	175"	90"	120"	150"	22'	150"	175"	90"	120"	150"
7.72m	5.08m	5.92m	3.05m	4.06m	5.08m	8.05m	4.57m	5.33m	2.74m	3.66m	4.57m
25.3'	200"	233"	120"	160"	200"	26.4'	180"	210"	108"	144"	180"
9.65m	6.35m	7.41m	3.81m	5.08m	6.35m	8.94m	5.08m	5.92m	3.05m	4.06m	5.08m
31.7'	250"	292"	150"	200"	250"	29.3'	200"	233"	120"	160"	200"
11.58m	7.62m	-	4.57m	6.1m	-	9.83m	5.59m	6.52m	3.35m	4.47m	5.59m
38'	300"	-	180"	240"	-	32.3'	220"	257"	132"	176"	220"

*Shaded rows are equivalent measurement in feet and inches.

Timing Mode Table

The projector can display several resolutions. The following table outlines the resolutions that can be displayed by the projector.

SIGNAL	RESOLUTION	FREQUENCY (KHZ)	REFRESH RATE (Hz)	XGA			WXGA		
				VIDEO	DIGITAL	ANALOG	VIDEO	DIGITAL	ANALOG
NTSC	--	15.734	60.0	○	--	--	○	--	--
PAL / SECAM	--	15.625	50.0	○	--	--	○	--	--
VESA	640 x 350	31.5	70.1	--	○	○	--	○	○
	640 x 350	37.9	85.1	--	○	○	--	○	○
	720 x 350	31.5	70	--	○	○	--	○	○
	640 x 400	31.5	70.1	--	○	○	--	○	○
	640 x 400	37.9	85.1	--	○	○	--	○	○
	720 x 400	31.5	70	--	○	○	--	○	○
	720 x 400	37.9	85	--	○	○	--	○	○
	640 x 480	31.5	60	--	○	○	--	○	○
	640 x 480	37.9	72.8	--	○	○	--	○	○
	640 x 480	37.5	75	--	○	○	--	○	○
	640 x 480	43.3	85	--	○	○	--	○	○
	800 x 600	35.2	56.3	--	○	○	--	○	○
	800 x 600	37.9	60.3	--	○	○	--	○	○
	800 x 600	46.9	75	--	○	○	--	○	○
	800 x 600	48.1	72.2	--	○	○	--	○	○
	800 x 600	53.7	85.1	--	○	○	--	○	○
	1024 x 768	48.4	60	--	○	○	--	○	○
	1024 x 768	56.5	70.1	--	○	○	--	○	○
	1024 x 768	57.7	72	--	○	○	--	○	○
	1024 x 768	60.0	75	--	○	○	--	○	○
	1024 x 768	68.7	85	--	○	○	--	○	○
	1280 x 1024	64.0	60	--	○	○	--	○	○
	1280 x 1024	80.0	75	--	○	○	--	○	○
1280 x 1024	91.1	85	--	○	○	--	○	○	
1280 x 768	47.4	60	--	○	○	--	○	○	
1600 x 1200	75.0	60	--	○	○	--	○	○	

Specifications

SIGNAL	RESOLUTION	FREQUENCY (KHZ)	REFRESH RATE (Hz)	XGA			WXGA		
				VIDEO	DIGITAL	ANALOG	VIDEO	DIGITAL	ANALOG
Macbook compatibility	800x600	--	60	--	○	○	--	○	○
	800x600	--	72	--	○	○	--	○	○
	800x600	--	75	--	○	○	--	○	○
	800x600	--	85	--	○	○	--	○	○
	1024x768	--	60	--	○	○	--	○	○
	1024x768	--	70	--	○	○	--	○	○
	1024x768	--	75	--	○	○	--	○	○
	1024x768	--	85	--	○	○	--	○	○
	1280x720	--	60	--	○	--	--	○	○
	1280x720	--	75	--	--	--	--	--	○
	1280x720	--	85	--	--	--	--	--	○
	1280x768	--	60	--	--	○	--	○	○
	1280x768	--	75	--	--	○	--	--	--
	1280x768	--	85	--	--	○	--	--	--
	1280x800	--	60	--	--	○	--	--	○
	1280x1024	--	60	--	○	--	--	○	--
	1280x1024	--	75	--	○	--	--	○	--
Mac book Pro (Intel) compatibility	800x600	--	60	--	○	○	--	○	○
	800x600	--	72	--	○	○	--	○	○
	800x600	--	75	--	○	○	--	○	○
	800x600	--	85	--	--	○	--	--	○
	1024x768	--	60	--	○	○	--	○	○
	1024x768	--	70	--	○	○	--	○	○
	1024x768	--	75	--	○	○	--	○	○
	1024x768	--	85	--	○	○	--	○	○
	1280x720	--	60	--	○	○	--	--	○
	1280x720	--	75	--	--	--	--	--	○
	1280x720	--	85	--	--	--	--	--	○
	1280x768	--	60	--	--	○	--	○	○
	1280x768	--	75	--	--	○	--	--	--
	1280x768	--	85	--	--	○	--	--	--
	1280x800	--	60	--	--	○	--	--	○
	1280x1024	--	60	--	--	○	--	--	○
	1280x1024	--	75	--	--	○	--	--	○

Specifications

SIGNAL	RESOLUTION	FREQUENCY (KHz)	REFRESH RATE (Hz)	XGA			WXGA		
				VIDEO	DIGITAL	ANALOG	VIDEO	DIGITAL	ANALOG
Power Mac G5 compatibility	800x600	--	56	--	--	--	--	--	--
	800x600	--	60	--	--	○	--	--	○
	800x600	--	72	--	--	○	--	--	○
	800x600	--	75	--	--	○	--	--	○
	800x600	--	85	--	--	○	--	--	○
	1024x768	--	60	--	--	○	--	--	○
	1024x768	--	70	--	--	○	--	--	○
	1024x768	--	75	--	--	○	--	--	○
	1024x768	--	85	--	--	○	--	--	○
	1280x720	--	60	--	--	--	--	--	--
	1280x720	--	75	--	--	--	--	--	--
	1280x720	--	85	--	--	--	--	--	--
	1280x768	--	60	--	--	--	--	--	○
	1280x800	--	60	--	--	--	--	--	--
	1280x1024	--	60	--	--	○	--	--	○
	1280x1024	--	75	--	--	○	--	--	○
1280x1024	--	85	--	--	--	--	--	○	
Power Mac G4 compatibility	800x600	--	56	--	○	--	--	○	--
	800x600	--	60	--	○	○	--	○	○
	800x600	--	72	--	○	○	--	○	○
	800x600	--	75	--	○	○	--	○	○
	800x600	--	85	--	○	○	--	○	○
	1024x768	--	60	--	○	○	--	○	○
	1024x768	--	70	--	○	○	--	○	○
	1024x768	--	75	--	○	○	--	○	○
	1024x768	--	85	--	○	○	--	○	○
	1280x720	--	60	--	--	--	--	--	○
	1280x720	--	75	--	--	--	--	--	○
	1280x720	--	85	--	--	--	--	--	○
	1280x768	--	60	--	--	--	--	○	○
	1280x800	--	60	--	--	○	--	--	○
	1280x1024	--	60	--	--	○	--	○	○
	1280x1024	--	75	--	--	○	--	○	○
1280x1024	--	85	--	--	--	--	○	--	

Specifications

SIGNAL	RESOLUTION	FREQUENCY (KHz)	REFRESH RATE (Hz)	XGA			WXGA		
				VIDEO	DIGITAL	ANALOG	VIDEO	DIGITAL	ANALOG
HDTV	1920 x 1080	33.8	30.0	○	--	--	○	--	--
	1920 x 1080	28.1	25.0	○	--	--	○	--	--
	1280 x 720	45.0	60.0	○	--	--	○	--	--
SDTV	720 x 576	31.3	50.0	○	--	--	○	--	--
	720 x 480	31.5	60.0	○	--	--	○	--	--

○: Frequency supported

--: Frequency not supported

The native resolution is 1024 x 768 for XGA, 1280 x 768 for WXGA. Resolution other than native mode may be displayed with uneven size of text or lines.

Projector Dimensions

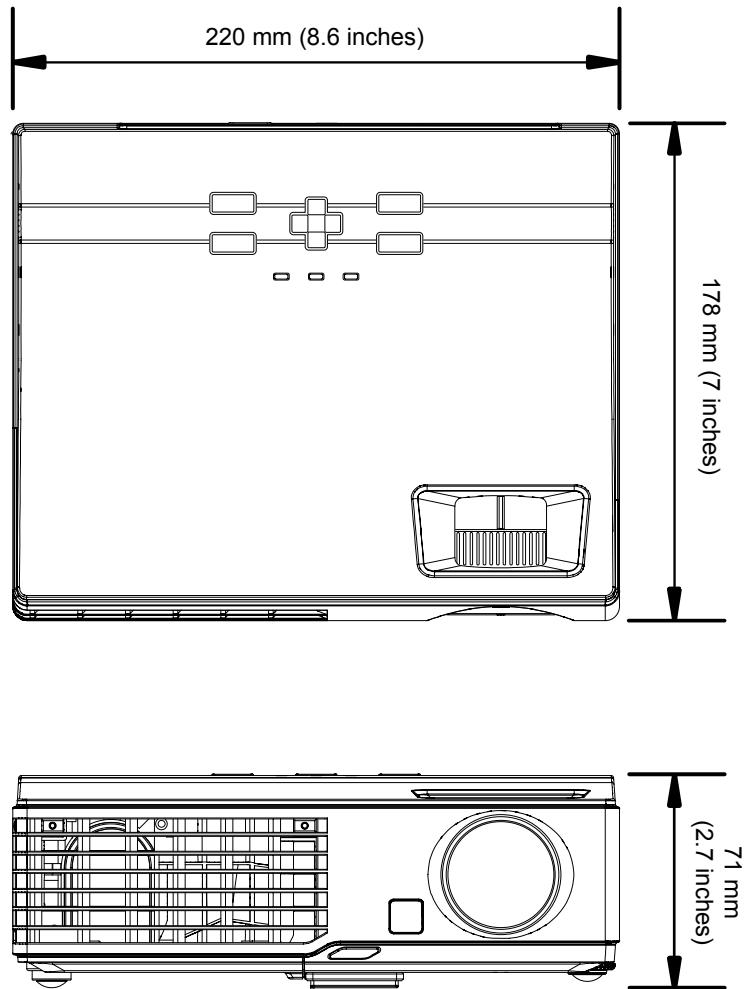

Regulatory Compliance

FCC Warning

This equipment has been tested and found to comply with the limits for a Class B digital device pursuant to Part 15 of the FCC Rules. These limits are designed to provide reasonable protection against harmful interference when the equipment is operated in a commercial environment.

This equipment generates, uses, and can radiate radio frequency energy and, if not installed and used in accordance with the instruction manual, may cause harmful interference to radio communications. Operation of this equipment in a residential area is likely to cause harmful interference in which case the user will be required to correct the interference at his/her own expense.

Changes or modifications not expressly approved by the parties responsible for compliance could void the user's authority to operate the equipment.

Canada

This class B digital apparatus complies with Canadian ICES-003.

Safety Certifications

FCC Class B, UL, C-UL, CE, CB, TUV-GS, CCC, ICES-003 (class B), EK, VCCI/PSE, PSB

EN 55022 Warning

This is a Class B product. In a domestic environment, it may cause radio interference, in which case the user may be required to take adequate measures. The typical use is in a conference room, meeting room, or auditorium.

RoHS Compliant

Copyright

This publication, including all photographs, illustrations and software, is protected under international copyright laws, with all rights reserved. Neither this manual, nor any of the material contained herein, may be reproduced without written consent of the author.

© Copyright August, 2007

Disclaimer

The information in this document is subject to change without notice. The manufacturer makes no representations or warranties with respect to the contents hereof and specifically disclaims any implied warranties of merchantability or fitness for any particular purpose. The manufacturer reserves the right to revise this publication and to make changes from time to time in the content hereof without obligation of the manufacturer to notify any person of such revision or changes.